

D. A. INTERNATIONAL CASTING CO.

Your Link to the International Market
Rail Car Division



This page was left blank intentionally



**“Our philosophy has always been ‘No job is ever too small,’ and we stand by that today, 29+ years later.” -
D.A.Kerrigan
CEO/President**

In 1996, David Alan Kerrigan founded D.A. International Casting Company. He started with nothing more than a vision of a successful casting business, a dedication to customer service, and a small rented space in central Ohio. With a couple of sand casting samples, and one potential customer, David began his quest to forge his way in the casting industry.

Today, D.A. International Casting Company has grown to serve over 800 customers and stocks over 1,100 different products—including an extensive supply of railcar replacement parts. David attributes part of this success to the purchase of Wine Railcar from Racine Steel. Since 1903, Wine Railcar has provided top quality castings to the railroad industry.

Over the years, D.A. has expanded their products to include premium investment castings, forgings, stampings and fabrications. This extensive inventory allows the company to now accommodate multiple markets, such as the railroad industry, mass transit, agriculture, heavy trucking, mining and telecommunication.

Visit D.A. International Casting Company’s state of the art 100,000 square-foot facility in Mansfield, Ohio, full of OEM and custom stock. See for yourself why we are an industry leader that is excited to meet your company’s specific needs.

QUALITY POLICY

Quality at DA International Casting Company is a fundamental business commitment.

Our goal is to become the best in the international marketplace in which we participate.

We are committed to providing our customers with the highest quality products and services, on time, at the best possible value.

It is DA International Casting Company's policy for all DA personnel to meet and exceed the requirements stated in our Quality Manual;

**Quality Products, Backed By Quality Service
& a Commitment to Excellence!**

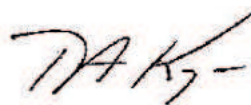

David A Kerrigan
President / CEO

The management of D. A. International Casting Company has formulated this policy. The policy is understood, maintained and implemented at all levels of the organization. Its focus is D. A. International Casting Company's organizational goals and the expectations and the needs of our customers. The policy is explained and discussed at general orientation training given to all existing and new employees. The policy is also posted in conspicuous locations throughout the company.

Meet Our Team



David Kerrigan
President/CEO
d.kerrigan@dacasting.com



Mark Carifa
VP of Operations/Sales
m.carifa@dacasting.com



Heather Kerrigan
Public Relations
h.kerrigan@dacasting.com



Jodi Ditmars
Office Manager/ Accounting
j.ditmars@dacasting.com

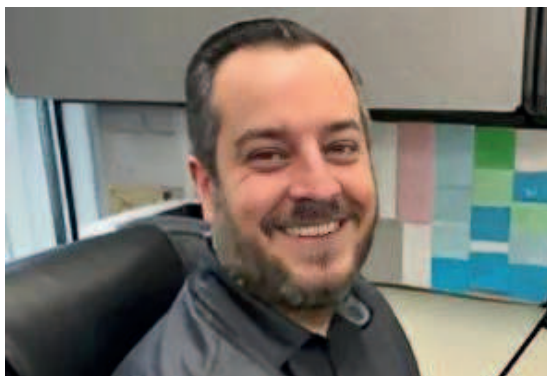

Ryan Rebillot
Quality Control
r.rebillot@dacasting.com



Chanelle Wichterman
Administrative Assistant
c.wichterman@dacasting.com

Flow Chart

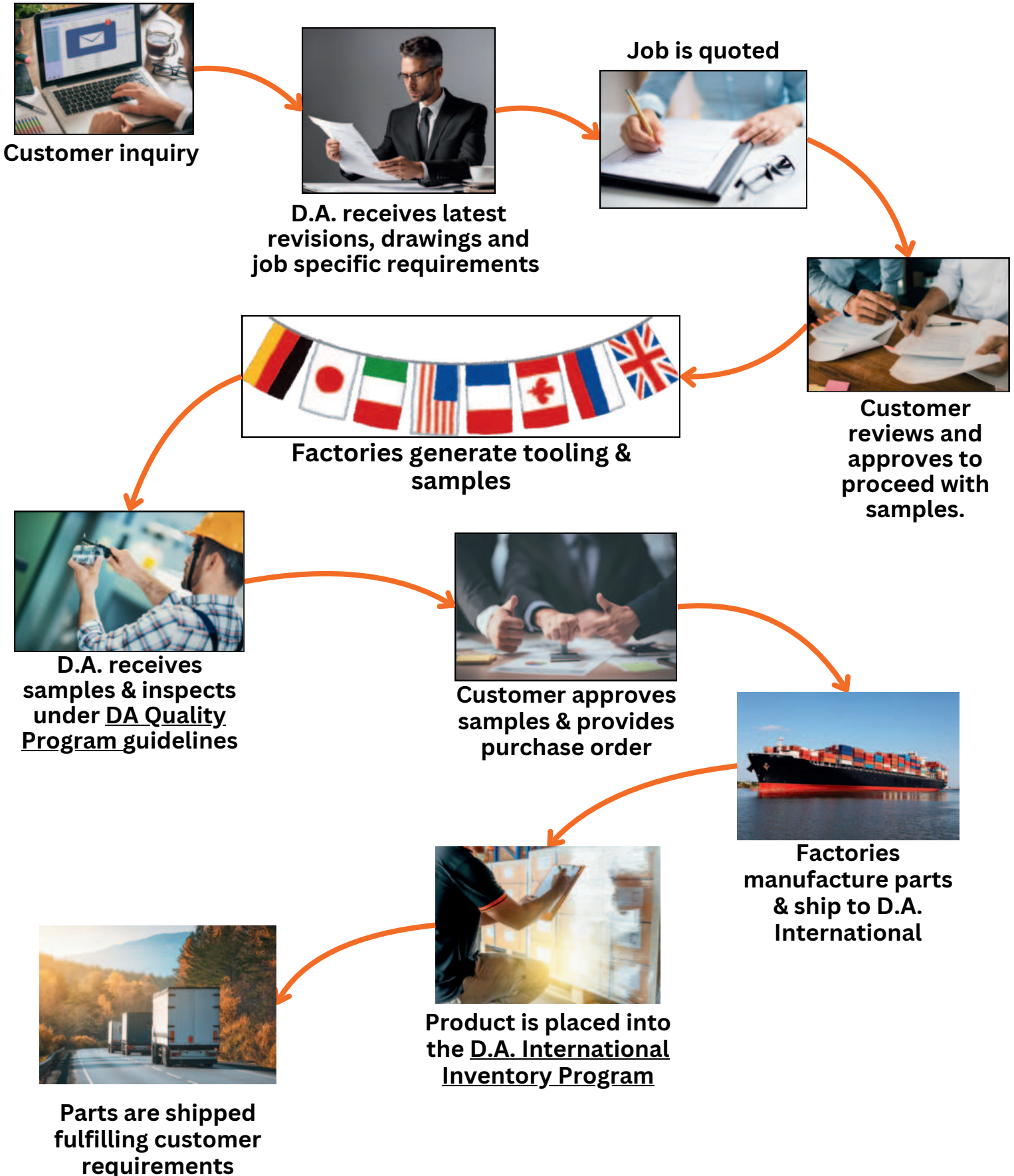

**Qualified Customers are placed in a D.A. International Inventory Program*
-On time delivery while maintaining customer inventory-*

Compressed Spring Assist Parts

We now offer pre-compressed spring assist assemblies specifically designed for rapid discharge open top hopper cars.

Key Benefits:

- Convenience: Our spring assemblies come pre-pinned and ready for immediate application, significantly simplifying the installation process.
- Time-Saving: Customers will experience a faster and more efficient setup, allowing for quicker deployment of railcars.

Compressed Spring Assist #1



D.A. Pt #	Alt Pt #	Description
DA-50066	093-40047	Bracket Cap for Spring Guide
DA-09048	50067	Spring Guide and Stop
DA-50038	131-40121	Spring for Spring Assist (White)
DA-14123	131-40123	Spring for Spring Assist (Green)

Compressed Spring Assist #2



D.A. Pt #	Alt Pt #	Description
DA-50039	093-40028	Spring Guide
DA-50034	50034	Spring Guide Adjustment Plate
DA-50038	131-40121	Spring for Spring Assist (White)
DA-14123	131-40123	Spring for Spring Assist (Green)

Spring Assist Parts

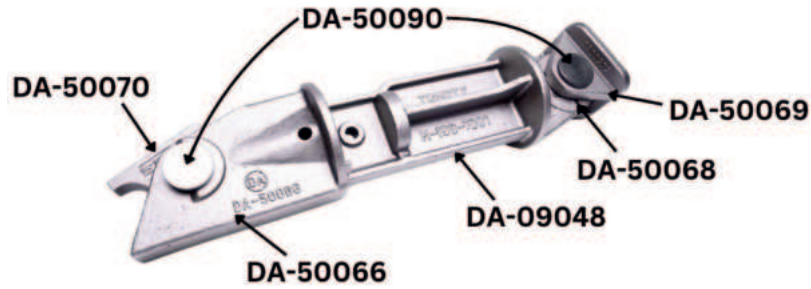

Spring Assist #1

D.A. Pt #	Alt Pt #	Description	Pg #
DA-09048	093-40048	Spring Guide Stop	66
DA-50066	093-40047	Spring Guide Bracket Cap	66
DA-50068	093-40049	Eccentric Nut	41
DA-50069	093-40050	Spring Assembly Bracket	65
DA-50070	093-40051	Lug for Spring Assist	57
DA-50090	MB-253-5090	Headed Pin	43

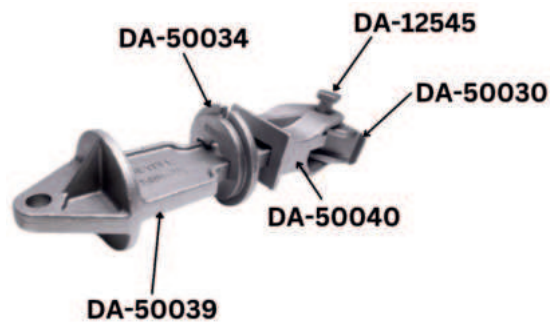

Spring Assist #2

D.A. Pt #	Alt Pt #	Description	Pg #
DA-50030	093-40030	Spring Fulcrum	42
DA-50034	093-40026	Spring Adjustment Plate	65
DA-50039	093-40028	Spring Guide	65
DA-50040	093-40029	Spring Guide Bracket	65
DA-12545	DA-11746	Hinge Pin	43

Wine Double Adjustable Locks

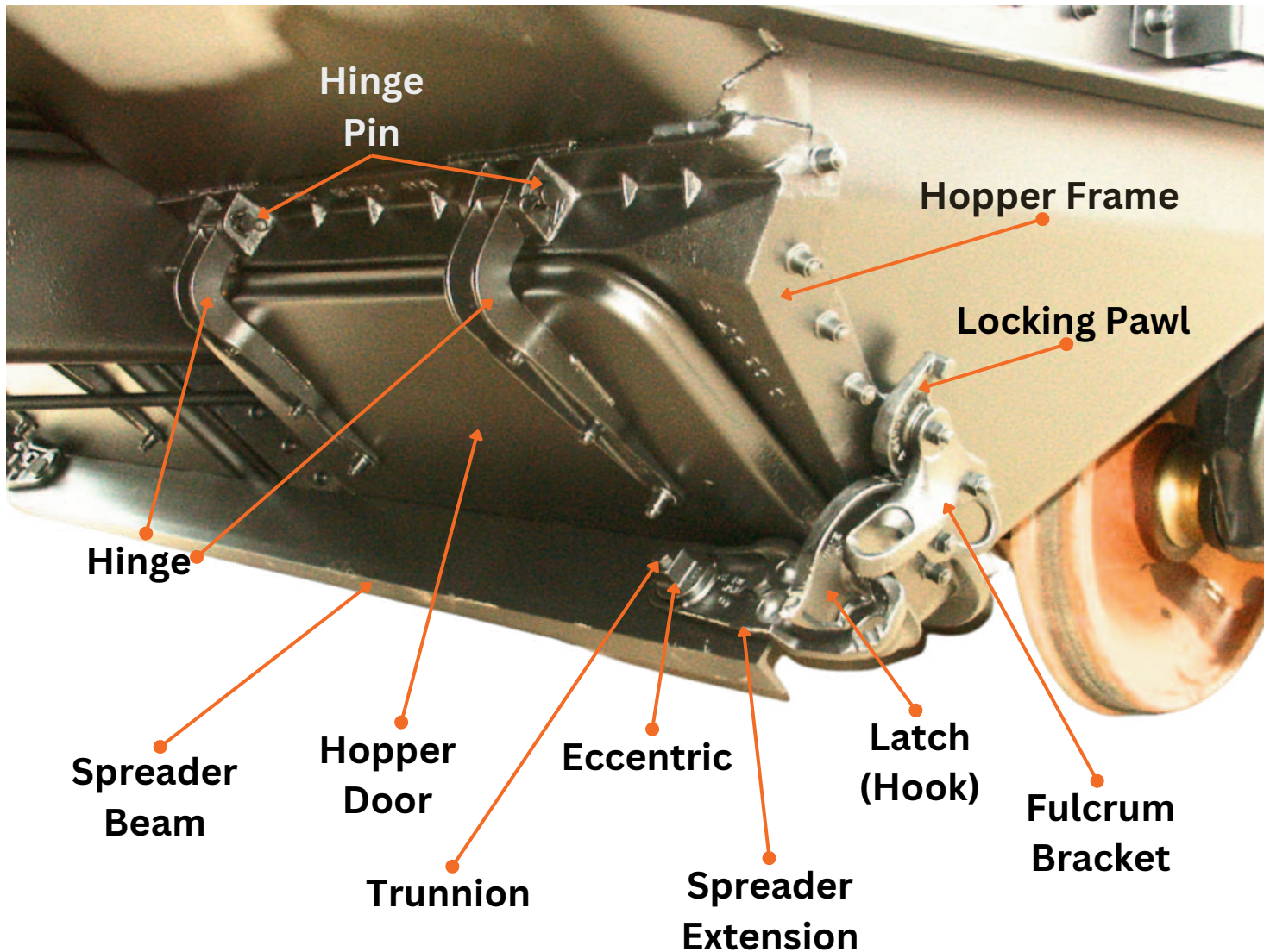

Complete Assembly Includes

- 1 - Hopper Frame
- 1 - Hopper Door (carbon or steel)
- 2 - Universal Hinges
- 2 - Hinge Pins
- 1 - Adjustable Eccentric
- 1 - Spreader Beam
- 1- Spreader Extension
- 1 - Locking Pawl
- 1- Fulcrum Bracket
- 1 - Latch (Hook)
- 1 - Trunnion

Wine Single Door Cam Lock

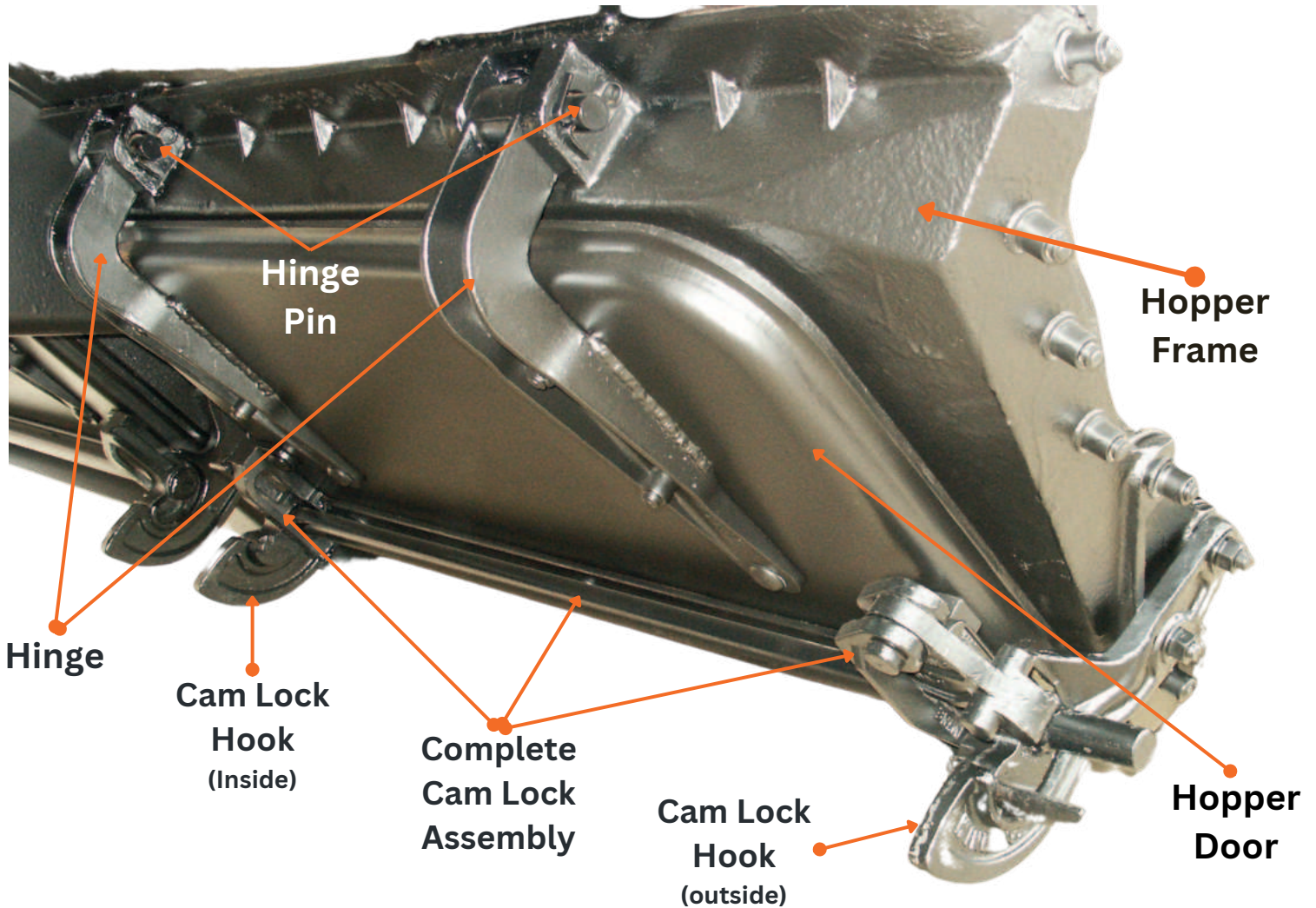

Complete Assembly Includes

- 1 - Hopper Frame
- 1 - Hopper Door
- 2 - Universal Hinges
- 2 - Hinge Pins
- 1 - Cam Lock Hook
- 1 - Cam Lock Assembly

Rapid - Release™

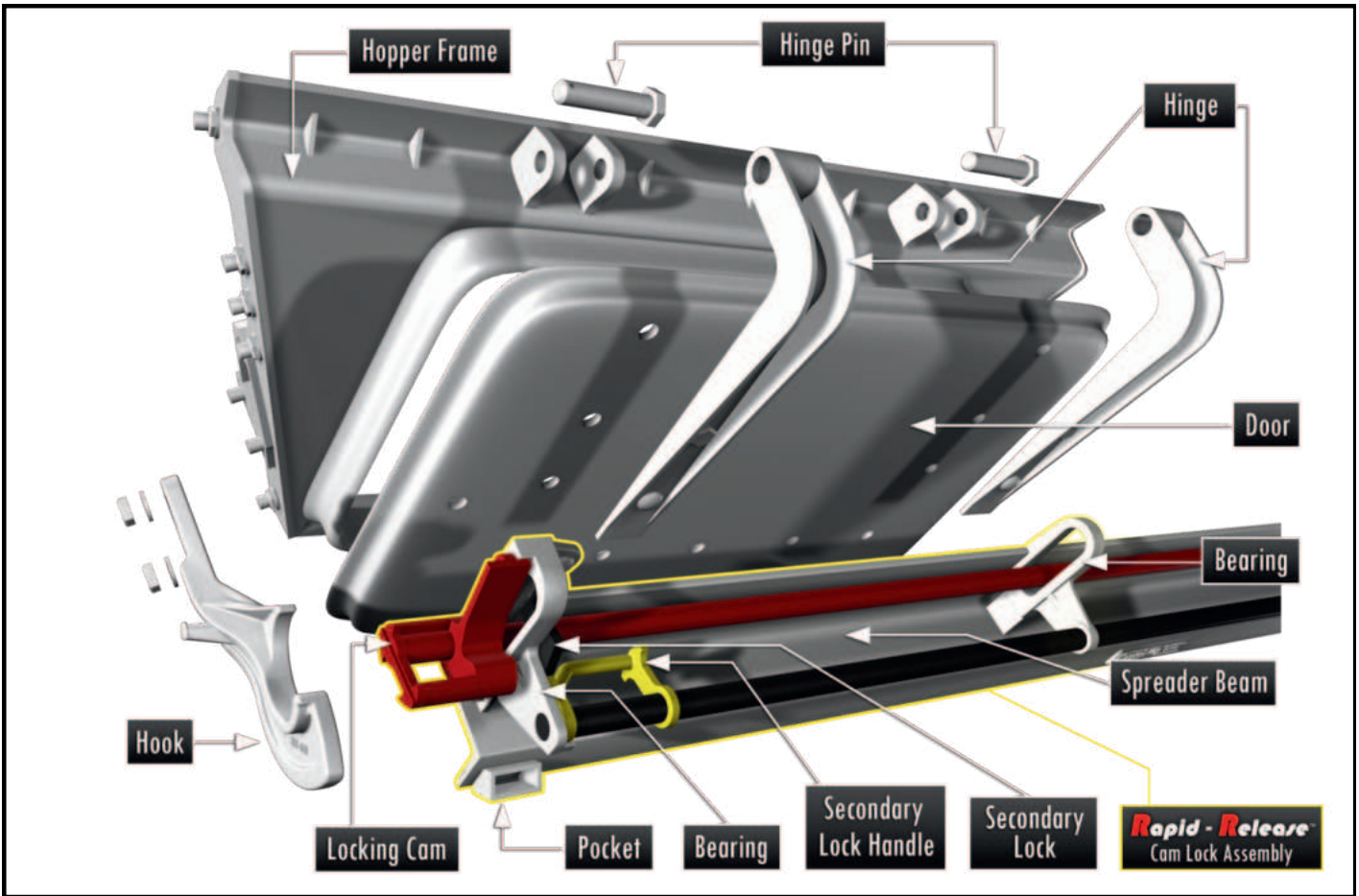

Door Size	Floor Slope	Hopper Frame P/N	Left Hook	Right Hook	RR Cam Lock Assembly P/N
Narrow	30 degree	HF-259/216	DA-00611, RR-611-L	DA-00612, RR-611-R	DA-00640-1
Wide	30 degree	HF-212	DA-00651, RR-651-L	DA-00652, RR-651-R	DA-00642-1
Wide	45 degree	HF-238	DA-00659, RR-659-L	DA-00660, RR-659-R	DA-00642-1

Rapid - Release™ is D. A. International Casting Company's most advanced WINE manual door lock system and it offers the following advantages:

- Designed using the same technology as the proven single door cam lock system, but requires fewer parts than that of a pair of single door cam locks.
- One person can operate a pair of hopper doors from either side of the rail car.
- Easy to install on new or existing conventional hopper cars.
- Built WINE tough and features dual outboard hooks to help support the commodity more evenly.
- This patented design features over-center locking cams which are self locking when the car is loaded.
- A secondary lock is built in for added safety and as a provision to operate in rotary dump service.

Monoloc Door Lock Parts



DA Pt # DA-11007
Alt Pt # PC-117
Description:
Latch Lug



DA Pt # DA-11900
Alt Pt # PC-119
Description:
Eccentric



DA Pt # DA-11008
Alt Pt # PC118
Description:
Center Bearing



DA Pt # DA-12000
Alt Pt # PC-120
Description:
Outer Bearing



DA Pt # DA-12003
Alt Pt # PC-123
Description:
Locking Lever



DA Pt # DA-12100
Alt Pt # PC-121
Description:
Latch

Index

	D.A. Pt #	Alt Pt #	Description	Weight	Pg #
A	DA-59411	029411	Adjustable Crankshaft 304SS	1.3	70
	DA-56278	006278	Adjustable Rod End	3.3	70
	DA-57595	027595	Anti Kick Back Pawl, Inner	0.8	70
	DA-57596	027596	Anti Kick Back Pawl, Outer	2.1	70
	DA-56381	056381	Auxiliary Lock Sill Bracket	1.0	70
B	DA-12200	PC-122	Bar Socket	4.5	24
	DA-61272	2CH-642-A	Bearing	8.6	24
	DA-63282	2CH-642-B	Bearing	8.6	24
	DA-14504	CL-4-A	Bearing	4.0	24
	DA-14514	CL-4-B	Bearing	4.0	24
	DA-13413	CL-3-A	Bearing	6.5	24
	DA-13423	CL-3-B	Bearing	6.5	24
	DA-23108	2CH-258	Bearing	1.8	24
	DA-00648	DA-648	Bearing Block	2.8	24
	DA-43433	PK-433	Bearing Block	0.5	24
	DA-53619	DA-000619	Bell Crank, AAR 55	9.4	24
	DA-53850	850.00	Bell Crank, AAR 66	11.8	24
	DA-11008	PC-118	Bearing, Center	5.5	28
	DA-12000	PC-120	Bearing, Outer	6.0	28
	DA-03654	DA-3654-140	Bolster Rim Replacement, 14" dia.	13.6	25
	DA-03710	DA-3709-141	Bolster Rim Replacement, 14" dia.	13.6	25
	DA-03711	DA-3709-160	Bolster Rim Replacement, 16" dia.	13.6	25
	DA-58326	058326	Bottom Crank & Extension, 5-5/16"	15.17	70
	DA-60169	60169	Bottom Crank Extension, 6-1/8"	15.5	70
	DA-18176	PK-176-A	Bracket	6.5	25
	DA-18276	PK-176-B	Bracket	6.5	25
	DA-30341	PK-341-A	Bracket	7.0	25
	DA-31341	PK-341-B	Bracket	7.0	25
	DA-45482	PK-482-A	Bracket	7.0	25
	DA-46482	PK-482-B	Bracket	7.0	25
	DA-48234	PK-482-A-34	Bracket	7.0	25
	DA-48334	PK-482-B-34	Bracket	7.0	25
	DA-56381	056381	Bracket, Auxiliary Lock Sill	1.0	70
	DA-50066	093-40047	Bracket Cap for Spring Guide	16.9	66
	DA-31513	MC-410	Bracket, Clevis	8.8	28
	DA-43511	MC-511	Bracket, Eyebolt	8.0	43
	DA-04268	T-130	Bracket, Fulcrum	9.3	43
	DA-28275-A	28275-A	Bracket for Gate Lock	2.8	44
	DA-28275-B	28275-B	Bracket for Gate Lock	2.8	44
	DA-30651	930651	Bracket, L, 1/4" Thick	4.0	58
	DA-15127	2CH-127-A	Bracket, Latch	2.0	57
DA-15128	2CH-127-B	Bracket, Latch	2.0	57	

	D.A. Pt #	Alt Pt #	Description	Weight	Pg #
B	DA-53229	053229	Bracket, Lock Post	0.8	69
	DA-52101	DA-501-RH	Bracket, Lock Weld/Assy. Seal Bracket	3.2	57
	DA-50772	06772-LH	Bracket, Lock Weld/Assy. Seal Bracket	3.2	57
	DA-50773	06773-RH	Bracket, Lock Weld/Assy. Seal Bracket	3.2	57
	DA-50774	7043	Bracket, Lock Weld/Assy. Seal Bracket	3.2	57
	DA-50775	7044	Bracket, Lock Weld/Assy. Seal Bracket	3.2	57
	DA-42498	MC-498	Bracket, Pipe	11.1	59
	DA-50069	093-40050	Bracket for Spring Assembly	6.2	66
	DA-11224	11224	Bracket,Vibrator	24.5	67
	DA-01710	M-167-5000	Bracket, Vibrator, Bolt on	36.0	67
	DA-01711	M-167-6000	Bracket, Vibrator, Weld on	41.2	67
	DA-11222	11222	Bracket,Vibrator	24.5	67
	DA		Bus Bar Clamps		74
	C	DA-43514	MC-514	Bushing	1.2
DA-58992		028992	Cam, Seal Cam Casting	1.8	69
DA-17012		CL-2-A	Cam Lock, In, RH	4.3	28
DA-17023		CL-2-B	Cam Lock, In, LH	4.3	28
DA-17111		CL-1-B	Cam Lock, Out, RH	5.5	28
DA-17011		CL-1-A	Cam Lock, Out, LH	5.5	28
DA-10001		CL-1-B-1	Cam Lock, Out, LH	5.5	28
DA-10011		CL-1-A-1	Cam Lock, Out, RH	5.5	28
DA-50562		053562	Cam, Lower Operating	1.3	70
DA-53559		053559	Cam, Operating	0.4	70
DA-59200		059200	Cam,Upper Operating	1.3	70
DA-41511		4CL-15-1	Camlock Assembly, (LH)	60.0	28
DA-41611		4CL-16-1	Camlock Assembly, (RH)	60.0	28
DA-41512		4CL-15-2	Camlock Assembly, (LH)	64.0	28
DA-41612		4CL-16-2	Camlock Assembly, (RH)	64.0	28
DA-00640		RR-640	Cam Lock Ass'y for Rapid Release	226.0	64
DA-00640-1		RR-640-1	Cam Lock Ass'y for Rapid Release	238.0	64
DA-00642		RR-642	Cam Lock Ass'y for Rapid Release	228.0	64
DA-00642-1		RR-642-1	Cam Lock Ass'y for Rapid Release		64
DA-42391		DA-4081	Capstan	7.8	27
DA-25690		25690	Capstan	9.6	27
DA-10080		10080	Capstan	16.4	27
DA-16298		16298	Capstan	14.0	27
DA-08843		E-8843	Capstan	14.1	27
DA-43413		DA-403	Capstan	13.0	27
DA-41932		DA-402-2	Capstan, Long, Heavy Duty	21.0	27
DA-41902		DA-402	Capstan, Long, Universal	17.6	27
DA-41890		DA-400	Capstan, Short, Universal	7.6	27

	D.A. Pt #	Alt Pt #	Description	Weight	Pg #	
C	DA-01211	2CH-121	Capstan, Outlet Gate	7.6	27	
	DA-33142	2CH-322	Capstan Lock	1.1	28	
	DA-91701	D965361-2	Capstan Reinforcement	2.8	28	
	DA-11008	PC-118	Center Bearing	5.5	28	
	DA-31513	MC-410	Clevis Bracket	8.8	28	
	DA-58330	038330	Clevis Casting	2.0	71	
	DA-53181	063181	Connector Clevis	2.8	71	
	DA-50000-G	50000G	Compressed Spring Assist Assembly #1	55.0	67	
	DA-50000-W	50000W	Compressed Spring Assist Assembly #1		67	
	DA-50002-G	50002G	Compressed Spring Assist Assembly #2	39.0	67	
	DA-50002-W	50002W	Compressed Spring Assist Assembly #2		67	
	DA-43431	2CH-685	Conversion Kit 61"	100.0	28	
	DA-41424	DA-404	Conversion Kit 66"	100.0	28	
	DA-41517	MC-477	Corner Cap	17.2	28	
	DA-70100	3864	Corner Cap	11.5	28	
	DA-41518	DA-700	Corner Cap	11.2	28	
	DA-32580	3799	Coupler Carrier Wear Plate	6.6	28	
	DA-32581	3258	Coupler Carrier Wear Plate	8.9	28	
	DA-40406	MC-406	Crossridge Foot Brace	7.6	29	
	DA-40900	MC-409	Crossridge Foot Brace	8.5	29	
	D	DA-42387	4CH-257	Door Gate Comp.	388.0	31
		DA-43398	4CH-418-RH	Door Gate Comp.	248.6	31
		DA-43388	4CH-418-LH	Door Gate Comp.	248.6	31
		DA-63401	4CH-641	Door Gate Comp.	516.5	31
		DA-49090	DA-490-L	Door Gate Comp. (LH)	210.0	31
		DA-49091	DA-490-R	Door Gate Comp. (RH)	210.0	31
		DA-63671	63671	Door Slide Ass'y.		35
DA-21111		2CH-259-1	Door Slide Ass'y.	168.9	35	
DA-31139		2CH-309	Door Slide Ass'y.	98.8	35	
DA-21304		3CH-214	Door Slide Ass'y.	200.9	35	
DA-31397		2CH-397	Door Slide Ass'y.	195.0	35	
DA-31313		3CH-303	Door Slide Ass'y.	187.5	35	
DA-32300		2CH-323	Door Slide Ass'y.	154.2	35	
DA-41254		2CH-404	Door Slide Ass'y.	91.3	36	
DA-41328		DA-41328	Door Slide Ass'y.	194.0	36	
DA-41329		3CH-429	Door Slide Ass'y.	195.6	36	
DA-61294		2CH-654-1	Door Slide Ass'y.	92.0	36	
DA-05374		Style #6	Door Slide Ass'y.	78.0	39	
DA-07987		DA-7987	Door Slide Ass'y.	154.0	37	
DA-08410		DA-08410	Door Slide Ass'y.	140.0	37	
DA-10062		MKE-10062	Door Slide Ass'y.	134.0	38	
DA-05765		Style #5	Door Slide Ass'y.	84.0	39	
DA-50202		Style #2	Door Slide Ass'y.	104.0	39	

D.A. Pt #	Alt Pt #	Description	Weight	Pg #
D DA-50203	Style #3	Door Slide Ass'y.	71.6	39
DA-50204	DA-50204	Door Slide Ass'y.		38
DA-50287	Style #1	Door Slide Ass'y.	126.0	34
DA-05804	Style #4	Door Slide Ass'y.	72.0	38
DA-07118	DA-7118	Door Slide Ass'y.	164.0	37
DA-78134	78134	Door Slide Ass'y.	145.0	34
DA-50289	50289	Door Slide Ass'y.	128.0	34
DA-71106	71106	Door Slide Ass'y.	166.0	32
DA-71131	71136	Door Slide Ass'y.		32
DA-71140	71140	Door Slide Ass'y.		33
DA-71150	71150	Door Slide Ass'y.		33
DA-74510	74510	Door Slide Ass'y.		33
DA-74520	74520	Door Slide Ass'y.		33
DA-50209	DA-50209	Door Slide Ass'y.	104.0	38
DA-50210	DA-50210	Door Slide Ass'y.		38
DA-71132	71132	Door Slide Ass'y.		32
DA-71132-SP	71132SP	Door Slide Ass'y.		32
DA-10070	MKE10070	Door Slide Ass'y.	180	38
DA-10066	10066	Door Slide Ass'y.		37
DA-50201	50201	Door Slide Ass'y.		34
DA-10061	10061	Door Slide Ass'y.		34
DA-10515	10515	Door Slide Ass'y.		37
DA-10054	10054	Door Slide Ass'y.		34
DA-11286	11286	Door Slide Ass'y.		38
DA-30006	3000627	Door Slide Ass'y.		40
DA-50037	5050037	Door Stop	2.1	29
DA-58030	58030	Door Stop	6.9	29
DA-00850-2	850-2	Draft Key Retainer	2.5	29
DA-00850-1	850-1	Draft Key Retainer Keeper	0.4	29
DA-45461	MC-461	Draft Lug, Front	41	30
DA-81777	578106-0	Draft Lug, Front	27.6	30
DA-07800	07800	Draft Lug, Front, Forging	26.5	30
DA-07481	107481-01	Draft Lug, Front, Forging	27.4	30
DA-18004	B-10804	Draft Lug, Rear	47.0	30
DA-10028	CB-128	Draft Lug, Rear	55	29
DA-32220	CB220	Draft Lug, Rear	42.5	30

Index

	D.A. Pt #	Alt Pt #	Description	Weight	Pg #	
D	DA-90346	B-9346	Draft Lug, Rear	40.0	30	
	DA-09462	09462	Draft Lug, Rear, Forging	10.4	30	
	DA-53704	53704	Draft Lug, Rear, LH	44.9	30	
	DA-53705	53705	Draft Lug, Rear, RH	44.9	30	
	DA-15155	50154-L	Draft Lug, Rear, LH, Forging	47.0	30	
	DA-15154	50154-R	Draft Lug, Rear, RH, Forging	41.0	30	
E	DA-60606	PK-6	Eccentric	1.6	41	
	DA-31236	PK-36	Eccentric	1.6	41	
	DA-11900	PC-119	Eccentric	6.5	41	
	DA-50068	093-40049	Eccentric Nut	1.4	41	
	DA-17025	CL-25	End Cap	0.4	41	
	DA-31808	PK-318-A	Extension	7.2	41	
	DA-31818	PK-318-B	Extension	7.2	41	
	DA-48908	PK-489-A	Extension	9.5	41	
	DA-48918	PK-489-B	Extension	9.5	41	
	DA-32101	PK-321-A	Extension	7.8	41	
	DA-32102	PK-321-B	Extension	7.8	41	
	DA-40431	PK-431-A	Extension	7.8	42	
	DA-41431	PK-431-B	Extension	7.8	42	
	DA-41454	PK-454-A	Extension	8.7	42	
	DA-42454	PK-454-B	Extension	8.7	42	
	DA-42457	PK-457-A	Extension	10.5	42	
	DA-43457	PK-457-B	Extension	10.5	42	
	DA-43487	PK-487-A	Extension	11.0	42	
	DA-44487	PK-487-B	Extension	11.0	42	
	DA-47134	PK-471-A-34	Extension	13.0	42	
	DA-47234	PK-471-B-34	Extension	13.0	42	
	DA-48483	PK-483-A	Extension	9.6	43	
	DA-48493	PK-483-B	Extension	9.6	43	
	DA-47487	PK-487-AX	Extension	11.0	42	
	DA-48487	PK-487-BX	Extension	11.0	42	
	DA-42467	MC-467	Eyebolt Bracket	7.4	43	
	DA-43511	MC-511	Eyebolt Bracket	8.0	43	
	F	DA-31780	DA-3178	Filler casting	3.0	43
		DA-28261	PK-261-A	Filler	2.4	43
		DA-29261	PK-261-B	Filler	2.4	43
		DA-12611	PK-261-A-1	Filler	2.4	43
		DA-22611	PK-261-B-1	Filler	2.4	43
DA-04268		T-130	Fulcrum Bracket	9.3	66	
DA-50030		093-40030	Fulcrum, Spring	3.0	43	
DA-44839		44839	Friction Shoe	23.0	43	

Index

	D.A. Pt #	Alt Pt #	Description	Weight	Pg #
G	DA-28275-A	28275-A	Gate Lock Bracket	2.8	44
	DA-28275-B	28275-B	Gate Lock Bracket	2.8	44
	DA-28274	28274	Gate Lock Bar Assembly	11.8	44
	DA-28273	28273	Gate Lock End Piece	2.4	44
	DA-53548	010892	Gear	13.5	71
	DA-30115	212-30115-LH	Guide Finger for Rave Door	1.4	42
	DA-30119	212-30119-RH	Guide Finger for Rave Door	1.2	42
H	DA-57029	057029	Handle Casting	7.2	71
	DA-50300	DA-503	Handle, Stainless Steel	0.6	44
	DA-81690	DA-800040	Hanger for Rave Door	1.6	44
	DA-53800	005155	Hasp, Body	4.1	71
	DA-53801	005157	Hasp, End	0.2	71
	DA-55159	005159	Hasp, Lock	4.3	71
	DA-53802	53802	Hasp, 2pc kit (body & end)	4.1	71
	DA-50090	MB-253-5090	Headed Pin	2.2	44
	DA-50016	093-40019	Hinge	7.0	45
	DA-42499	MC-499	Hinge	6.1	45
	DA-23261	HF-261	Hinge	7.5	45
	DA-14011	UC-6, 11140-11	Hinge	8.1	45
	DA-12130	V-12130	Hinge	7.1	45
	DA-50092	093-40389	Hinge	4.6	45
	DA-50092-HD	1098746	Hinge, Heavy Duty	6	45
	DA-50017		Hinge Butt	3.8	45
	DA-14043	UC-43	Hinge Butt	10.4	45
	DA-43512	MC-512	Hinge Butt	5.0	45
	DA-40391	093-40391	Hinge Butt	4.5	45
	DA-30113	212-30113	Hinge Leaf , Three Knuckle	1.4	46
	DA-30112	212-30112	Hinge Leaf , Two Knuckle	0.9	46
	DA-12545	DA-11746	Hinge Pin	1.4	44
	DA-54494	041494	Hold Open Arm	0.9	71
	DA-22527	PK-27-X	Hook	8.0	46
	DA-34234	PK-342-34	Hook	8.5	46
	DA-43481	PK-481	See 48134		46
	DA-48134	PK-481-34	Hook	8.0	46
	DA-17209	CL-19-A	Hook (In)	9.0	46
	DA-17219	CL-19-B	Hook (In)	9.0	46
	DA-17028	CL-28	Hook (In)	10.0	46
	DA-17160	CL-60	Hook (In)	9.0	46
	DA-17204	CL-24-A	Hook (In)	8.5	47
	DA-17224	CL-24-B	Hook (In)	8.5	47
	DA-17309	CL-39-A	Hook (In)	8.1	47
	DA-17339	CL-39-B	Hook (In)	8.1	47

Index

D.A. Pt #	Alt Pt #	Description	Weight	Pg #
H DA-17503	CL-13-A	Hook (In)	9.0	46
DA-17513	CL-13-B	Hook (In)	9.0	46
DA-17156	CL-66-A	Hook (Out)	8.0	47
DA-17166	CL-66-B	Hook (Out)	8.0	47
DA-17349	CL-59-A	Hook (Out)	7.9	47
DA-17359	CL-59-B	Hook (Out)	7.9	47
DA-17605	CL-65-A	Hook (Out)	7.5	47
DA-17665	CL-65-B	Hook (Out)	7.5	47
DA-17512	CL-12-A	Hook (Out)	8.9	47
DA-17612	CL-12-B	Hook (Out)	8.9	47
DA-28020	CL-20-A	Hook (Out)	9.5	48
DA-28120	CL-20-B	Hook (Out)	9.5	48
DA-23527	CL-27-A	Hook (Out)	8.0	48
DA-23627	CL-27-B	Hook (Out)	8.0	48
DA-17308	CL-38-A	Hook (Out)	7.1	48
DA-17338	CL-38-B	Hook (Out)	7.1	48
DA-00611	RR-611-L	Hook for Rapid Release (LH)	8.7	64
DA-00612	RR-611-R	Hook for Rapid Release (RH)	8.7	64
DA-00651	RR-651-L	Hook for Rapid Release (LH)	8.7	64
DA-00652	RR-651-R	Hook for Rapid Release (RH)	8.4	64
DA-00659	RR-659-L	Hook for Rapid Release (LH)	9	64
DA-00660	RR-659-R	Hook for Rapid Release (RH)	8.3	64
DA-17060	D1706039	Hopper Door for RD car, Alum.	53.0	49
DA-17002	D-170-7002	Hopper Door LH for RD car	56.0	49
DA-17003	D-170-7003	Hopper Door RH for RD car	56.0	49
DA-47008	D-004-7008	Hopper Door for RD Car, Inner	573.0	50
DA-47009	D-004-7009	Hopper Door for RD Car, Outer	606.0	50
DA-176004	D-170-6004	Hopper Door Large	97.0	43
DA-176003	D-170-6003	Hopper Door Small	114.0	52
DA-76031	DA-76031	Hopper Door, Trapezoidal, LH	127.5	50
DA-76035	DA76035	Hopper Door, Trapezoidal, RH	127.5	50
DA-00402	200402	Hopper Door, Aluminum, LH		49
Open Top Hopper Door Size Chart Page 51				
DA-176005	176005	Hopper Door, Carbon Steel, Small, 3/8" Thick		52
DA-176005-H	176005H	Hopper Door, Carbon Steel, Small, 3/8" Thick w/ spreader holes		52
DA-76005	D-170-6051	Hopper Door, 1/4" Thick, Small, Stainless Steel	62	54
DA-76005-H	76005H	Hopper Door, 3/8" Thick w/ Spreader Holes, Small, Carbon Steel	102	54
DA-176004-AL	176004AL	Hopper Door, 1/4" Thick, Large, Aluminum		54
DA-76006-H	76006H	Hopper Door, 1/4" Thick w/ Spreader Holes		54
DA-76006	76006	Hopper Door, Large, Stainless Steel, 1/4" Thick	150	54
DA-176006-H	176006H	Hopper Door, Large, Carbon Steel, 3/8" Thick, w/ Spreader Holes		53
DA-176006	176006	Hopper Door, Large, 3/8" Thick	150	53
DA-176004-SP	D-170-6004	Hopper Door, Large w/ Spreader Holes, 5/16" Thick	124	53

Index

D.A. Pt #	Alt Pt #	Description	Weight	Pg #
H DA-176004-CL	176004CL	Hopper Door w/ Cam Lock Holes, Large, 5/16" Thick		53
DA-176003-H	176003H	Hopper Door w/ Spreader Beam Holes, Small, Carbon Steel, 5/16" Thick	102	52
DA-176003-CL	176003CL	Hopper Door, Small w/ Cam Lock Holes, 5/16" Thick		52
DA-52965	C52965	hopper door, trapezoidal, RH	97	50
DA-75793-1	75793-010	Hopper Door, 5083 H116 Aluminum		49
DA-75793-2	75793-020	Hopper Door, 5083 H116 Aluminum		49
DA-25212	HF-212-A	Hopper Frame	175.0	55
DA-25213	HF-212-B	Hopper Frame	175.0	55
DA-25210	HF-210-A	Hopper Frame	182.0	55
DA-25211	HF-210-B	Hopper Frame	182.0	55
DA-18259	HF-259-A-18	Hopper Frame	163.0	55
DA-18260	HF-259-B-18	Hopper Frame	163.0	55
DA-10238	HF-238-A-10	Hopper Frame	170	56
DA-10239	HF-238-B-10	Hopper Frame	170	56
L DA-20209	2CH-209	Latch	0.5	57
DA-12100	PC-121	Latch	11.5	57
DA-15127	2CH-127-A	Latch Bracket	2.0	57
DA-15128	2CH-127-B	Latch Bracket	2.0	57
DA-11007	PC-117	Latch Lug	3.5	57
DA-20210	2CH-210	Latch Retainer	0.5	57
DA-53555	O53555	Lever Adapter	0.7	71
DA-50044	O93-40035	Lever End, Door Operating	20.0	57
DA-57687	O27687	Lock Side Bolt	3.0	71
DA-17012	CL-2-A	Lock, Cam (In)	4.3	26
DA-17023	CL-2-B	Lock, Cam (In)	4.3	26
DA-17111	CL-1-B	Lock, Cam (Out)	5.5	26
DA-17011	CL-1-A	Lock, Cam (Out)	5.5	26
DA-10011	CL-1-A-1	Lock, Cam (Out)	5.5	26
DA-10001	CL-1-B-1	Lock, Cam (Out)	5.5	26
DA-33142	2CH-322	Lock for Capstan	1.1	28
DA-58978	O28978	Lock Wedge Assembly	14.8	72
DA-58979	O28979	Lock Wedge Assembly	14.7	72
DA-58980	O28980	Lock Wedge Assembly	14.9	72
DA-52090	DA-500-LH	Lock Weld/Assy. Seal Brkt.	3.2	57
DA-52101	DA-501-RH	Lock Weld/Assy. Seal Brkt.	3.2	57
DA-50772	O6772-LH	Lock Weld/Assy. Seal Brkt.	3.2	57
DA-50773	O6773-RH	Lock Weld/Assy. Seal Brkt.	3.2	57
DA-50774	7043	Lock Weld/Assy. Seal Brkt.	3.2	58
DA-50775	7044	Lock Weld/Assy. Seal Brkt.	3.2	58
DA-53229	O53229	Lock Post Bracket	0.8	70
DA-12003	PC-123	Locking Lever	1.5	57

Index

	D.A. Pt #	Alt Pt #	Description	Weight	Pg #
L	DA-10082-A	10082A	Lock Lift Follower, Outside, Short	.71	58
	DA-10082-B	10082B	Lock, Door Lock, Short	.72	58
	DA-41902	DA-402	Long Universal Capstan	17.6	27
	DA-10081-A	10081A	Lock Lift Follower, Outside, Long	1.31	58
	DA-10081-B	10081B	Lock, Door Lock, Long	.72	58
	DA-50562	053562	Lower Operating Cam	1.3	70
	DA-30651	930651	L Bracket, 1/4" Thick	4.0	58
	DA-23193	023193-0	Lock, Wedge Lock Assembly	16.0	67
	DA-50070	093-40051	Lug for Spring Assist	2.8	66
O	DA-54494	041494	Open Arm Hold	0.9	71
	DA-01211	2CH-121	Outlet Gate Capstan	7.6	27
	DA-68845	204910055	Outlet Gate Lock Kit		58
	DA-12000	PC-120	Outer Bearing	6.0	58
	DA-53559	053559	Operating Cam	0.4	70
P	DA-57595	027595	Pawl, Anti Kick Back, Inner	0.8	70
	DA-57596	027596	Pawl, Anti Kick Back, Outer	2.1	70
	DA-17417	CL-7	Pawl	3.0	59
	DA-28112	PK-2-A	Pawl	2.4	59
	DA-29112	PK-2-B	Pawl	2.4	59
	DA-32343	PK-343-A	Pawl	3.0	59
	DA-34343	PK-343-B	Pawl	3.0	59
	DA-43480	PK-480-A	Pawl	2.5	59
	DA-44480	PK-480-B	Pawl	2.5	59
	DA-33178	2CH-328	Pinion Gear	5.0	59
	DA-50090	MB-253-5090	Pin, Headed for Spring Guide	2.2	44
	DA-21129	2CH-29	Pinion Gear	2.8	60
	DA-69400	DA-69400	Pinion Gear	3.0	60
	DA-70209	DA-29-A	Pinion Gear	2.7	60
	DA-70210	DA-29-B	Pinion Gear	2.7	60
	DA-33179	2CH-327	Pinion Gear	9.6	60
	DA70211	70211	Pinion Gear, 1-3/8"		60
	DA-52082	DA-502	Pinion Gear	4.2	60
	DA-70212	70212	Pinion Gear	1.1	60
	DA-10129	10129	Pinion Gear	2.1	60
	DA-41051	1CH-409-3	Pinion Shaft, 30-1/2"	20.7	61
	DA-21934	1CH-409-1	Pinion Shaft, 30-3/4"		61
	DA-42010	1CH-409-11	Pinion Shaft, 30"	22.0	61
	DA-01733	DA-01733	Pinion Shaft, 33"	18	61
	DA-01723	DA-01723	Pinion Shaft, 36-3/8"	18.0	61
	DA-31001	1CH-340-1	Pinion Shaft, 38-3/8"	26.2	61
	DA-31018	1CH-340-18	pinion shaft, 40.5"		61
	DA-31033	1CH-340-3	Pinion Shaft, 61"	41.6	61
	DA-33026	1CH-340-16	Pinion Shaft, 66"	44.9	61

Index

D.A. Pt #	Alt Pt #	Description	Weight	Pg #	
P	DA-34005	1CH-340-5	pinion shaft, 53"	61	
	DA-34805	1CH-340-13	pinion shaft, 60.5"	61	
	DA-07248	DA-07248	Pinion Shaft, 48"	21.6	61
	DA-07177	DA-07177	Pinion Shaft, 65"	29.1	61
	DA-30304	DA-502-SS	Pinion-Stainless Steel	4.2	60
	DA-21130	DA-29-304-SS	Pinion-Stainless Steel	2.8	60
	DA-57715	O27715	Pipe Bottom Extension	6.6	72
	DA-42498	MC-498	Pipe Bracket	11.1	59
	DA-92266	MB-999-5186	Plunger Nose	0.8	59
R	DA-13096	2CH-156	Rack	5.1	62
	DA-33181	2CH-331	Rack	6.5	62
	DA-00185	DA-10085-2	Rack	14.5	62
	DA-10111	10111	Rack	7.0	62
	DA-41423	DA-423	Rack	10.5	62
	DA-42328	DA-7028	Rack	6.0	62
	DA-42339	DA-4029	Rack	5.4	62
	DA-42340	DA-4030	Rack	6.4	62
	DA-42372	DA-422	Rack	9.4	62
	DA-42382	VPA-6182	Rack	19.8	63
	DA-42444	955002	Rack	8.5	63
	DA-50094	DA-50094	Rack	21.0	63
	DA-70213	DA70213	Rack	3.9	62
	DA-70215	70215	Rack		62
	DA-00640	RR-640	Rapid Release Cam Lock Ass'y	226	64
	DA-00640-1	RR-640-1	Rapid Release Cam Lock Ass'y	238.0	64
	DA-00642	RR-642	Rapid Release Cam Lock Ass'y	228	64
	DA-00642-1	RR-642-1	Rapid Release Cam Lock Ass'y		64
	DA-00611	RR-611-L	Rapid Release Hook (LH)	8.7	64
	DA-00612	RR-611-R	Rapid Release Hook (RH)	8.7	64
	DA-00651	RR-651-L	Rapid Release Hook (LH)	8.7	64
	DA-00652	RR-651-R	Rapid Release Hook (RH)	8.4	64
	DA-00659	RR-659-L	Rapid Release Hook (LH)	9	64
	DA-00660	RR-659-R	Rapid Release Hook (RH)	8.3	64
	DA-34175	005463	Ratchet Pawl	0.9	72
	DA-57650	O27650	Ratchet Pawl	1.0	72
	DA-32272	M-336-5072	Release Handle	3.1	66
	DA-57400	O27400	Rod End Casting	1.0	72
	DA-52340	O02340	Roller Assembly	3.6	72
	DA-57385-1	O27349	Roller Housing w/ Hook, Primed	14.0	72
	DA-50498-1	O50498	Roller Housing w/o Hook, Primed	13.0	72
	DA-57382	O27382	Roller Stop Casting	2.40	72

Index

	D.A. Pt #	Alt Pt #	Description	Weight	Pg #
S	DA-43279	DA-43279	Seal Cam Assembly	1.5	66
	DA-58992	028992	Seal Cam Casting	1.8	70
	DA-10992	DA-10992	Spreader Beam	95	65
	DA-10993	DA-10993	Spreader Beam		65
	DA-10994	DA-10994	Spreader Beam	97	65
	DA-50069	093-40050	Spring Assembly Bracket	6.2	65
	DA-50030	093-40030	Spring Fulcrum	3.0	43
	DA-14123	131-40123	Spring for Spring Assist (Green)	15.7	66
	DA-50038	131-40121	Spring for Spring Assist (White)	13.0	66
	DA-50039	093-40028	Spring Guide	17.5	66
	DA-50034	50034	Spring Guide Adjustment Plate	4.89	66
	DA-09048	50067	Spring Guide and Stop	25.3	66
	DA-50040	093-40029	Spring Guide Bracket	10.0	66
	DA-50066	093-40047	Spring Guide Bracket Cap	16.9	66
	DA-16966	E-16096-B	Striker & Front Draft Lug	106.0	65
	T	DA-30001	DA-30001	Striker & Front Draft Lug	178.0
DA-14100		D-10410-C	Striker & Front Draft Lug	182.0	65
DA-33505		3505A	Truck Damp	8.0	67
DA-33605		PK-35	Trunnion Washer	1.6	67
U	DA-37345	PK-345	Trunnion Washer	2.0	67
	DA-43455	PK-455	Trunnion Washer	1.7	67
	DA-59200	059200	Upper Operating Cam	1.3	70
V	DA-11224	11224	Vibrator Bracket	24.5	67
	DA-01710	M-167-5000	Vibrator Bracket, Bolt on	36.0	67
	DA-01711	M-167-6000	Vibrator Bracket, Weld on	41.2	67
W	DA-11222	11222	Vibrator Bracket	24.5	67
	DA-32580	3799	Wear Plate, Coupler Carrier	6.6	28
	DA-32581	3258	Wear Plate, Coupler Carrier	8.9	28
	DA-23193	23193	Wedge Lock Assembly	16.0	67

This page was left blank intentionally



DA Pt # DA-12200
Alt Pt # PC-122
Description:
 Bar Socket



DA Pt # DA-61272
Alt Pt # 2CH-642-A
Description:
 Bearing



DA Pt # DA-63282
Alt Pt # 2CH-642-B
Description:
 Bearing



DA Pt # DA-14504
Alt Pt # CL-4-A
Description:
 Bearing



DA Pt # DA-14514
Alt Pt # CL-4-B
Description:
 Bearing



DA Pt # DA-13413
Alt Pt # CL-3-A
Description:
 Bearing



DA Pt # DA-13423
Alt Pt # CL-3-B
Description:
 Bearing

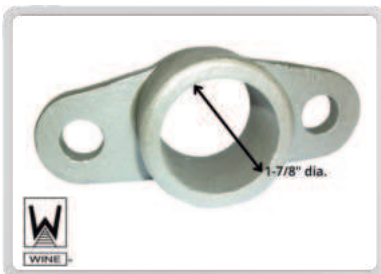

DA Pt # DA-23108
Alt Pt # 2CH-258
Description: 1-7/8" dia.
 Bearing



DA Pt # DA-00648
Alt Pt # DA-648
Description:
 Bearing Block



DA Pt # DA-43433
Alt Pt # PK-433
Description:
 Bearing Block



DA Pt # DA-53619
Alt Pt # DA-000619
Description:
 Bell Crank, AAR 55



DA Pt # DA-53850
Alt Pt # 00850
Description:
 Bell Crank, AAR 66

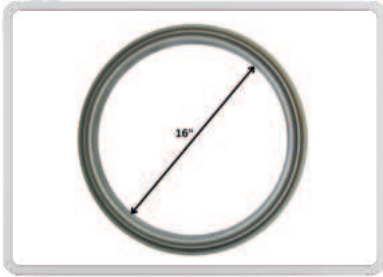

DA Pt # DA-03711
Alt Pt # DA-3709-160
Description: 16"
 Bolster Rim Replacement

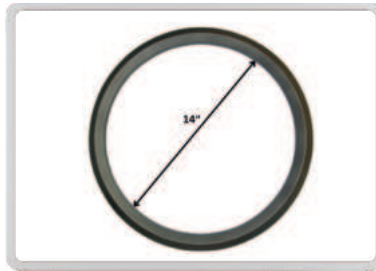

DA Pt # DA-03654
Alt Pt # DA-3654-140
Description: 14"
 Bolster Rim Replacement

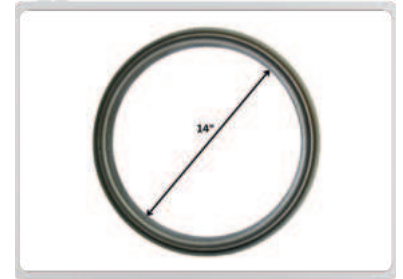

DA Pt # DA-03710
Alt Pt # DA-3709-141
Description: 14"
 Bolster Rim Replacement



DA Pt # DA-00000
Alt Pt # 00000
Description:
 Wine Railcar Products



DA Pt # DA-18176
Alt Pt # PK-176-A
Description:
 Bracket



DA Pt # DA-18276
Alt Pt # PK-176-B
Description:
 Bracket



DA Pt # DA-30341
Alt Pt # PK-341-A
Description:
 Bracket



DA Pt # DA-31341
Alt Pt # PK-341-B
Description:
 Bracket



DA Pt # DA-45482
Alt Pt # PK-482-A
Description:
 Bracket



DA Pt # DA-46482
Alt Pt # PK-482-B
Description:
 Bracket



DA Pt # DA-48234
Alt Pt # PK-482-A-34
Description:
 Bracket



DA Pt # DA-48334
Alt Pt # PK-482-B-34
Description:
 Bracket



DA Pt # DA-43514
Alt Pt # MC-514
Description:
 Bushing



DA Pt # DA-00000
Alt Pt # 00000
Description:
 Wine Railcar Products



DA Pt # DA-17012
Alt Pt # CL-2-A
Description: RH
 Cam Lock (In)



DA Pt # DA-17023
Alt Pt # CL-2-B
Description: LH
 Cam Lock (In)



DA Pt # DA-17111
Alt Pt # CL-1-B
Description: RH
 Cam Lock (Out)



DA Pt # 17011
Alt Pt # CL-1-A
Description: LH
 Cam Lock (out)



DA Pt # DA-10001
Alt Pt # CL-1-B-1
Description: RH
 Cam Lock (out)



DA Pt # DA-10011
Alt Pt # CL-1-A-1
Description: LH
 Cam Lock (out)

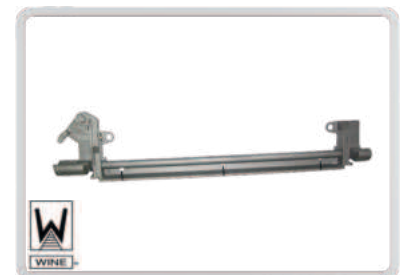

DA Pt # DA-41511
Alt Pt # 4CL-15-1
Description: Short
 Camlock Assembly - LH



DA Pt # DA-41611
Alt Pt # 4CL-16-1
Description: Short
 Camlock Assembly - RH

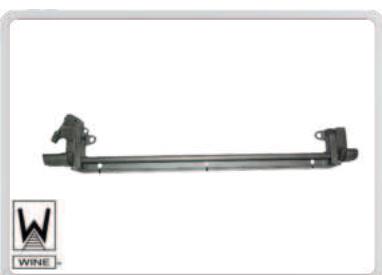

DA Pt # DA-41512
Alt Pt # 4CL-15-2
Description: Long
 Camlock Assembly - LH



DA Pt # DA-41612
Alt Pt # 4CL-16-2
Description: Long
 Camlock Assembly - RH

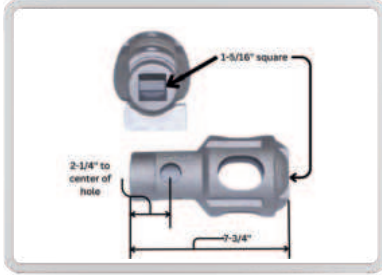

DA Pt # DA-42391
Alt Pt # DA-4081
Description:
Capstan

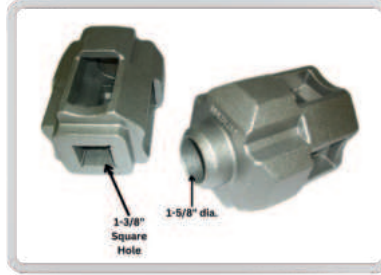

DA Pt # DA-25690
Alt Pt # 2569
Description:
Capstan

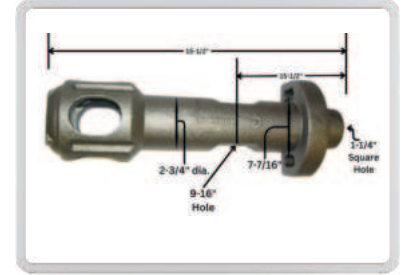

DA Pt # DA-10080
Alt Pt # 10080
Description:
Capstan



DA Pt # DA-16298
Alt Pt # CL-1-A
Description:
Capstan



DA Pt # DA-08843
Alt Pt # E-8843
Description:
Capstan

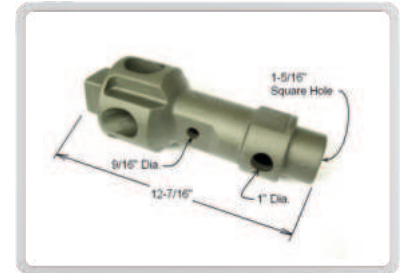

DA Pt # DA-43413
Alt Pt # DA-403
Description:
Capstan



DA Pt # DA-41932
Alt Pt # DA-402-2
Description: Long
Capstan, Heavy Duty

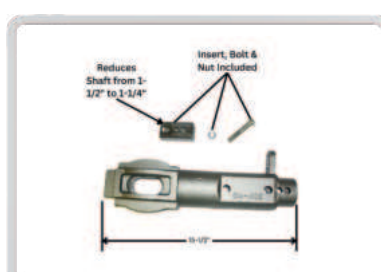

DA Pt # DA-41902
Alt Pt # DA-402
Description: Long
Capstan, Universal,

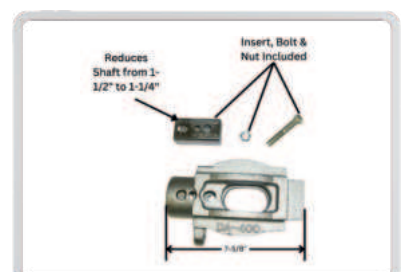

DA Pt # DA-41890
Alt Pt # DA-400
Description: Short
Capstan, Universal

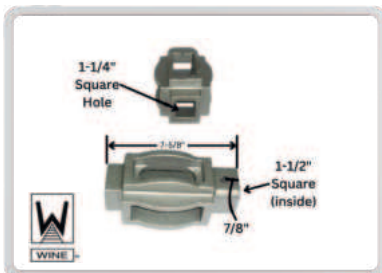

DA Pt # DA-01211
Alt Pt # 2CH-121
Description:
Capstan - Outlet Gate



DA Pt # DA-00000
Alt Pt # 00000
Description:
Wine Railcar Products



DA Pt # DA-00000
Alt Pt # 00000
Description:
Wine Railcar Products



DA Pt # DA-33142
Alt Pt # 2CH-322
Description:
 Capstan Lock



DA Pt # DA-91701
Alt Pt # D965361-2
Description:
 Capstan Reinforcement



DA Pt # DA-11008
Alt Pt # PC118
Description:
 Center Bearing



DA Pt # DA-31513
Alt Pt # MC-410
Description:
 Clevis Bracket

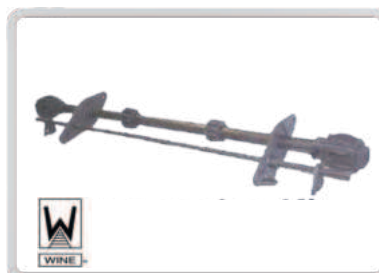

DA Pt # DA-43431
Alt Pt # 2CH-685
Description:
 Conversion Kit - 61"



DA Pt # DA-41424
Alt Pt # DA-404
Description:
 Conversion Kit - 66"



DA Pt # DA-41517
Alt Pt # MC-477
Description:
 Corner Cap



DA Pt # DA-70100
Alt Pt # 3864
Description:
 Corner Cap Forging



DA Pt # DA-41518
Alt Pt # DA-700
Description:
 Corner Cap

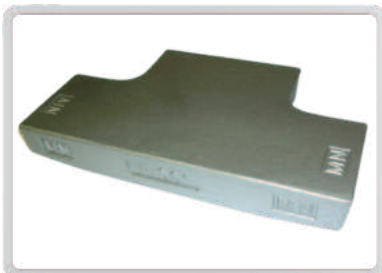

DA Pt # DA-32580
Alt Pt # 3799
Description: 9/32" Thick
 Coupler Carrier Wear Plate



DA Pt # DA-32581
Alt Pt # 3258
Description: 15/32" Thick
 Coupler Carrier Wear Plate



DA Pt # DA-00000
Alt Pt # 00000
Description:
 Wine Railcar Products



DA Pt # DA-40406
Alt Pt # MC-406
Description:
 Crossridge Foot Brace



DA Pt # DA-40900
Alt Pt # MC-409
Description:
 Crossridge Foot Brace



DA Pt # DA-00000
Alt Pt # 00000
Description:
 Wine Railcar Products



DA Pt # DA-50037
Alt Pt # 50037
Description:
 Door Stop



DA Pt # DA-00850-2
Alt Pt # 1009899
Description:
 Draft Key Retainer



DA Pt # DA-00850-1
Alt Pt # 1009688
Description:
 Draft Key Retainer Keeper



DA Pt # DA-00000
Alt Pt # 00000
Description:
 Wine Railcar Products



DA Pt # DA-00000
Alt Pt # 00000
Description:
 Wine Railcar Products



DA Pt # DA-10028
Alt Pt # CB-128
Description:
 Draft Lug, Rear





DA Pt # DA-07800
Alt Pt # 7800
Description:
 Draft Lug - Front



DA Pt # DA-07481
Alt Pt # 107481-01
Description:
 Draft Lug, Front, Forging

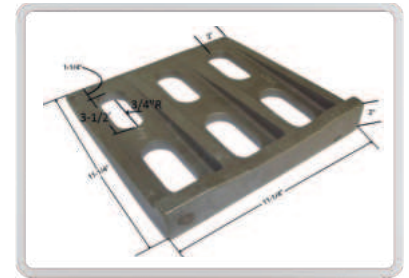

DA Pt # DA-81777
Alt Pt # 578106-0
Description:
 Draft Lug - Front



DA Pt # DA-45461
Alt Pt # MC-461
Description:
 Draft Lug - Front

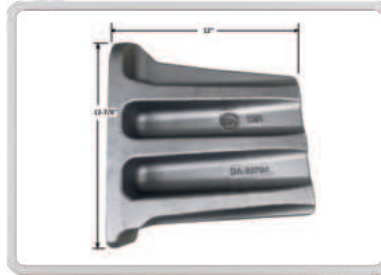

DA Pt # DA-53704
Alt Pt # 53704
Description:
 Draft Lug, Forging, Rear



DA Pt # DA-53705
Alt Pt # 53705
Description:
 Draft Lug, Forging, Rear

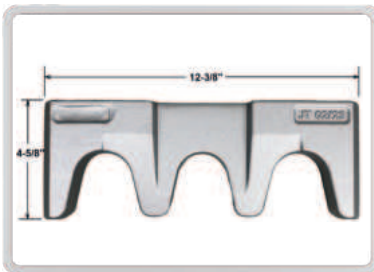

DA Pt # DA-09462
Alt Pt # 09462
Description:
 Draft Lug, Rear, Forging



DA Pt # DA-15155
Alt Pt # 50154-L
Description:
 Draft Lug, Rear, LH



DA Pt # DA-15154
Alt Pt # 50154-R
Description:
 Draft Lug, Rear, RH

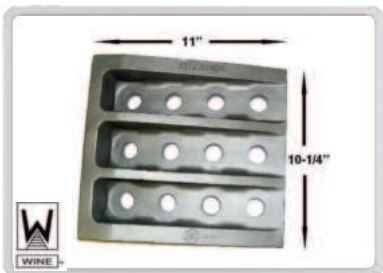

DA Pt # DA-32220
Alt Pt # CB-220
Description:
 Draft Lug

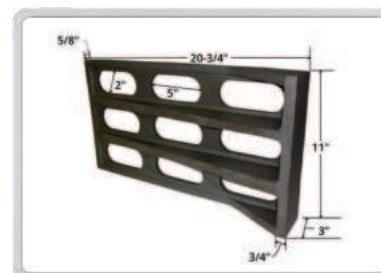

DA Pt # DA-90346
Alt Pt # B-9346
Description:
 Draft Lug, Rear

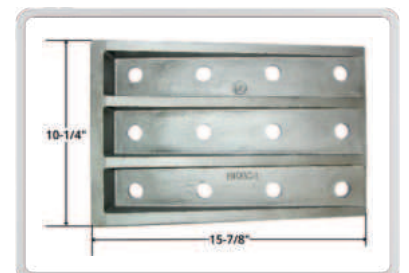

DA Pt # DA-18004
Alt Pt # B-10804
Description:
 Draft Lug, Rear

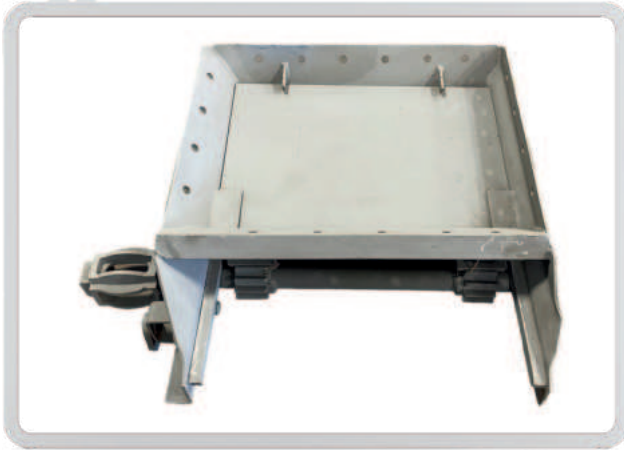

DA Pt # DA-49090
Alt Pt # DA-490-L
Description: Door Gate Complete - LH



DA Pt # DA-49091
Alt Pt # DA-490-R
Description: Door Gate Complete - RH



DA Pt # DA-43388
Alt Pt # 4CH-418-LH
Description: Door Gate Complete

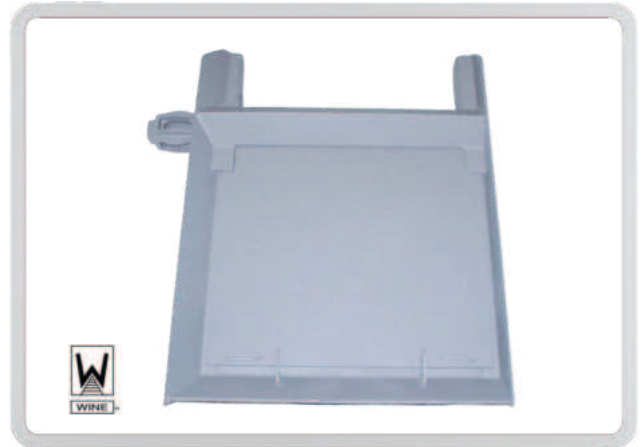

DA Pt # DA-43398
Alt Pt # 4CH-418-RH
Description: Door Gate Complete

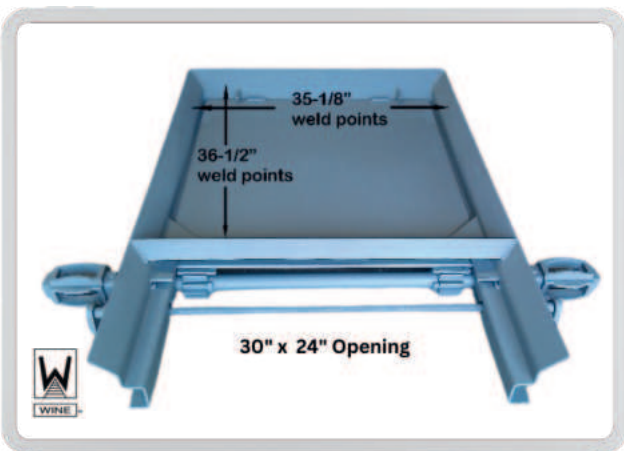

DA Pt # DA-42387
Alt Pt # 4CH-257
Description: Door Gate Complete

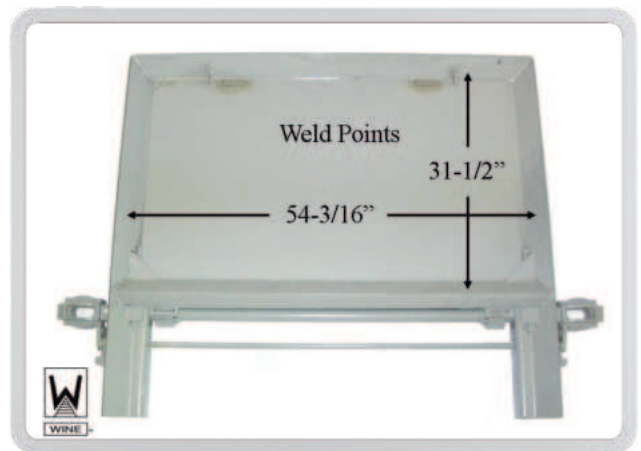

DA Pt # DA-63401
Alt Pt # 4CH-641
Description: Door Gate Complete

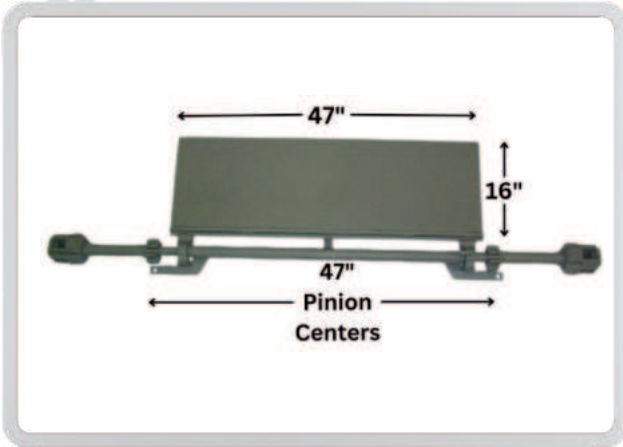

DA Pt # DA-71106
Alt Pt # 71106
Description: Door Slide Assembly



DA Pt # DA-71131
Alt Pt # 71131
Description: Door Slide Assembly

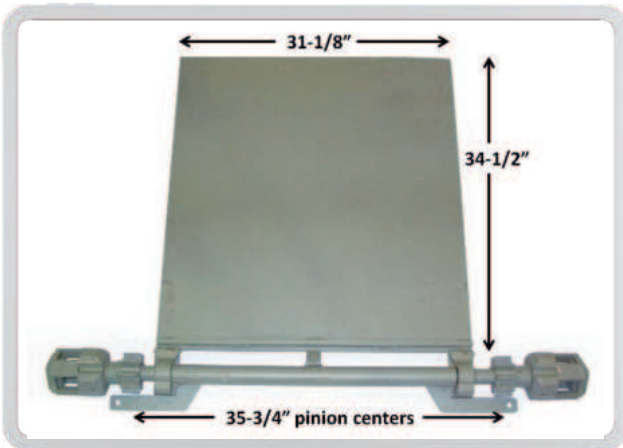

DA Pt # DA-71132
Alt Pt # 71132
Description: Door Slide Assembly

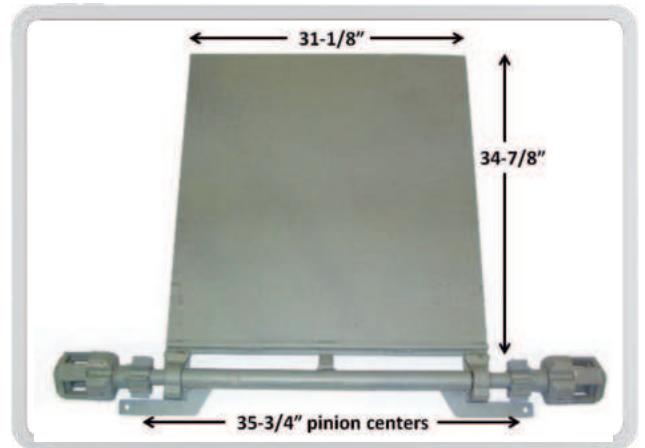

DA Pt # DA-71132-SP
Alt Pt # 71132SP
Description: Door Slide Assembly

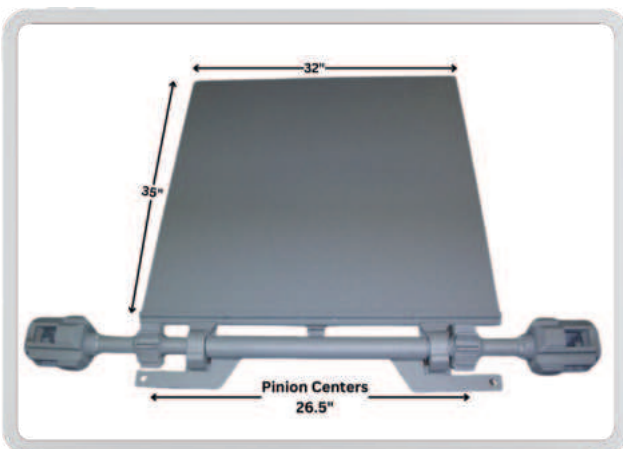

DA Pt # DA-71133
Alt Pt # 71133
Description: Door Slide Assembly



DA Pt # DA-00000
Alt Pt # 00000
Description: Wine Railcar Products

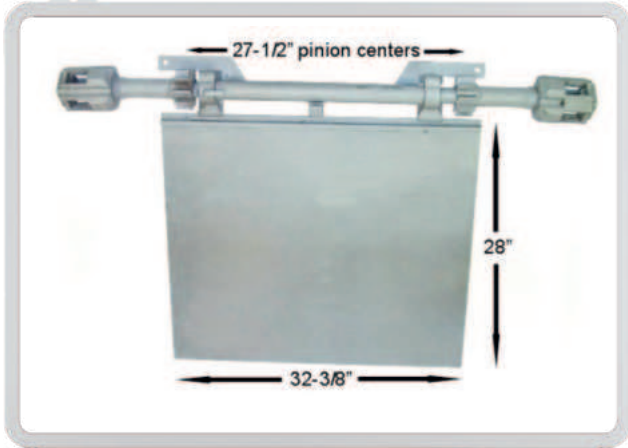

DA Pt # DA-71140
Alt Pt # 71140
Description: Door Slide Assembly

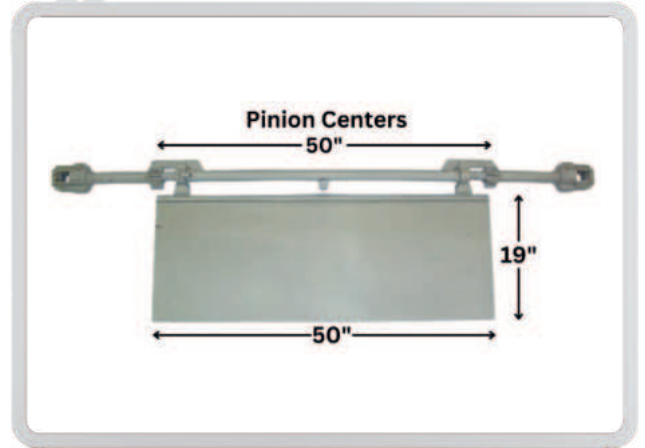

DA Pt # DA-71150
Alt Pt # 71150
Description: Door Slide Assembly

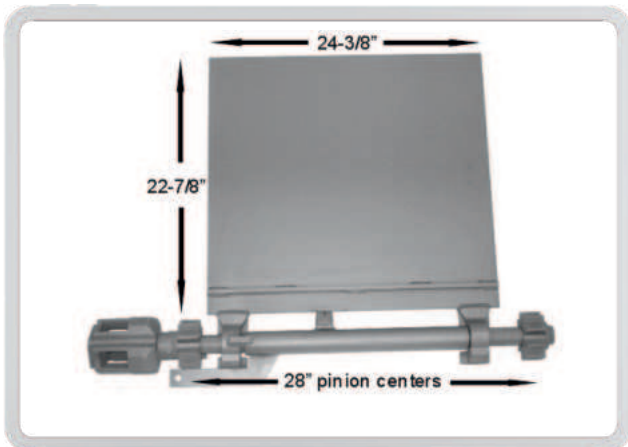

DA Pt # DA-74510
Alt Pt # 74510
Description: Door Slide Assembly - LH

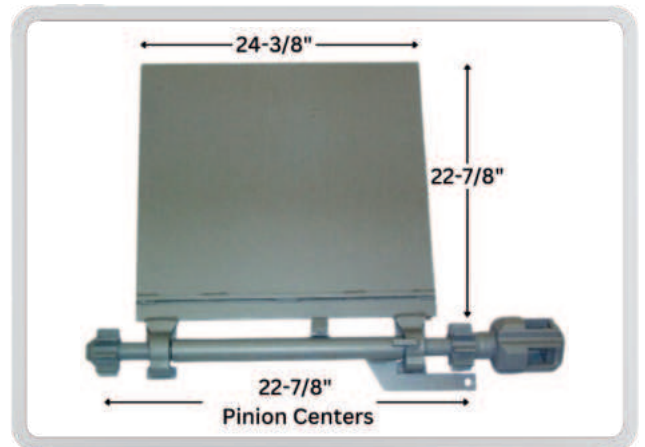

DA Pt # DA-74520
Alt Pt # 74520
Description: Door Slide Assembly - RH

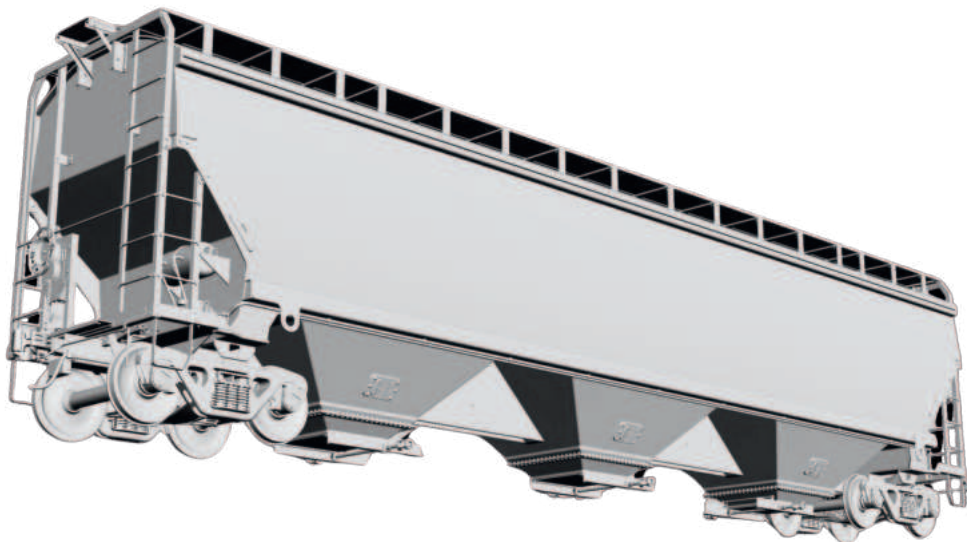

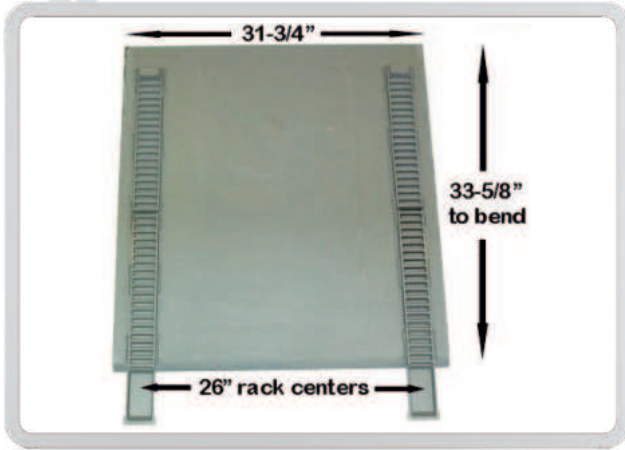

DA Pt # DA-78134
Alt Pt # 78134
Description: Door Slide Assembly

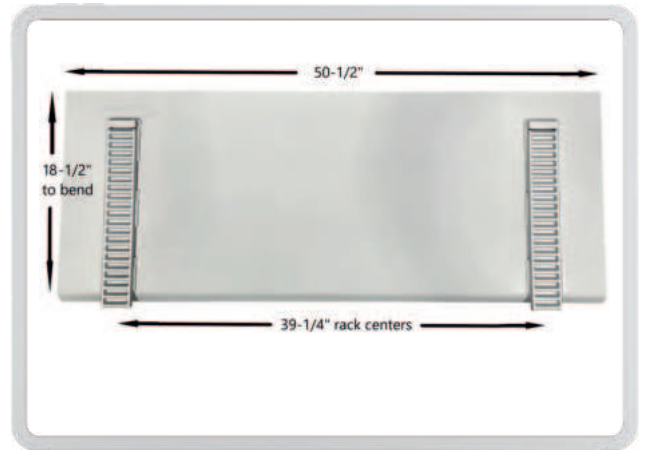

DA Pt # DA-50201
Alt Pt # 50201
Description: Door Slide Assembly

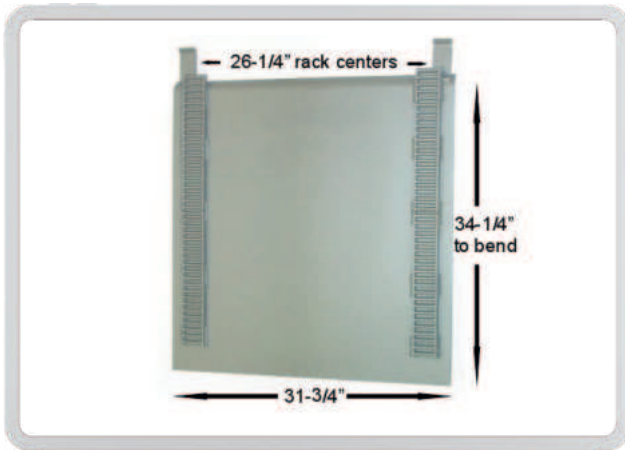

DA Pt # DA-50287
Alt Pt # Style # 1
Description: Door Slide Assembly

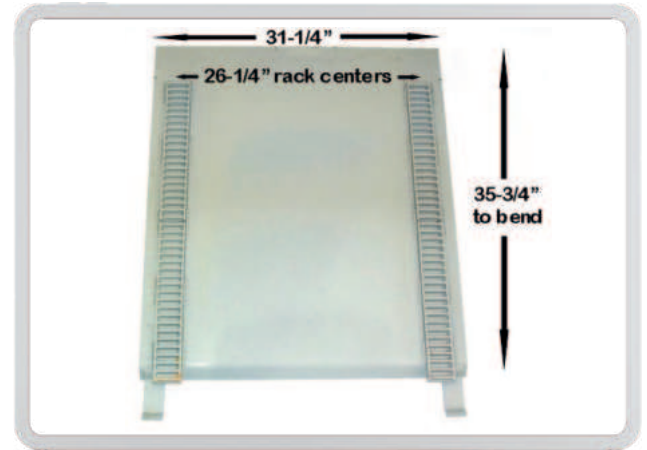

DA Pt # DA-50289
Alt Pt # 50289
Description: Door Slide Assembly



DA Pt # DA-10054
Alt Pt # 10054
Description: Door Slide Assembly



DA Pt # DA-10061
Alt Pt # 10061
Description: Door Slide Assembly

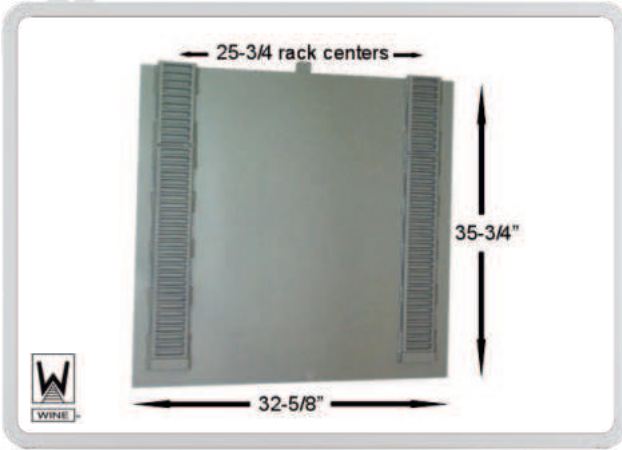

DA Pt # DA-21111
Alt Pt # 2CH-259-1
Description: Door Slide Assembly

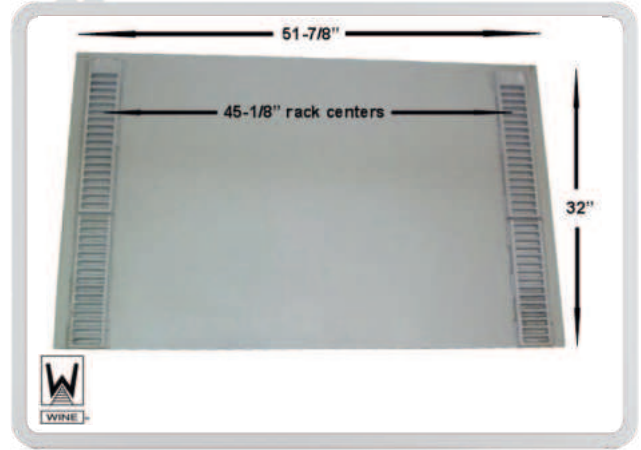

DA Pt # DA-21304
Alt Pt # 3CH-214
Description: Door Slide Assembly

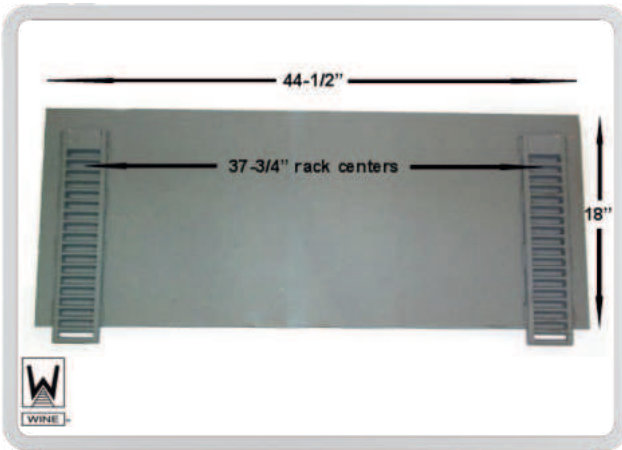

DA Pt # DA-31139
Alt Pt # 2CH-309
Description: Door Slide Assembly

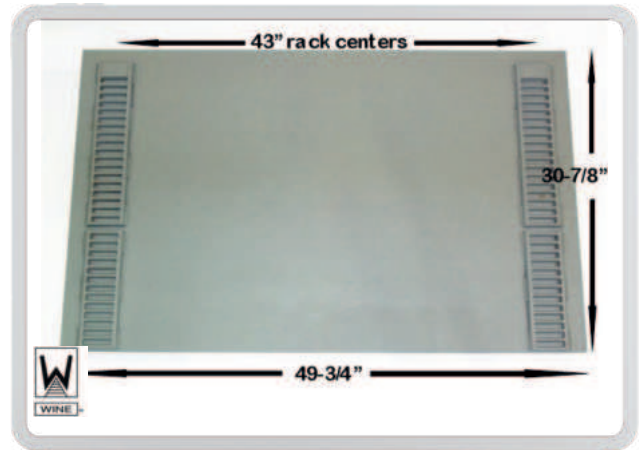

DA Pt # DA-31313
Alt Pt # 3CH-303
Description: Door Slide Assembly

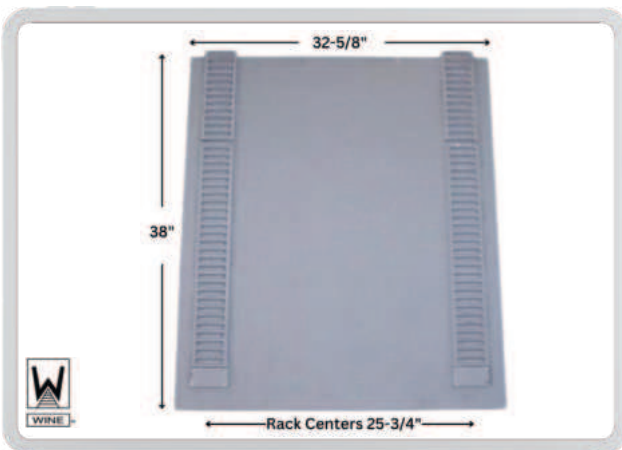

DA Pt # DA-32300
Alt Pt # 2CH-323
Description: Door Slide Assembly

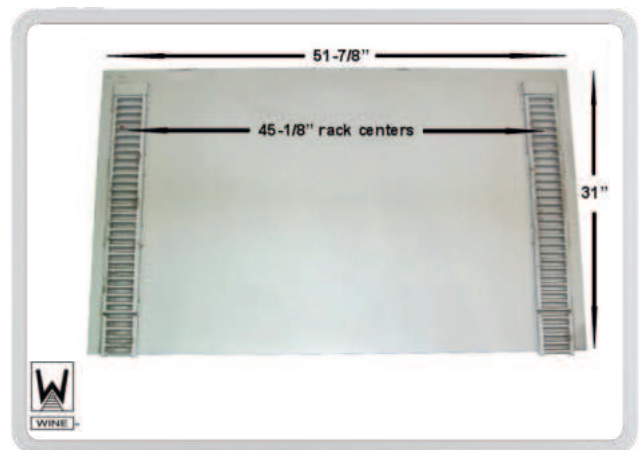

DA Pt # DA-31397
Alt Pt # 2CH-397
Description: Door Slide Assembly

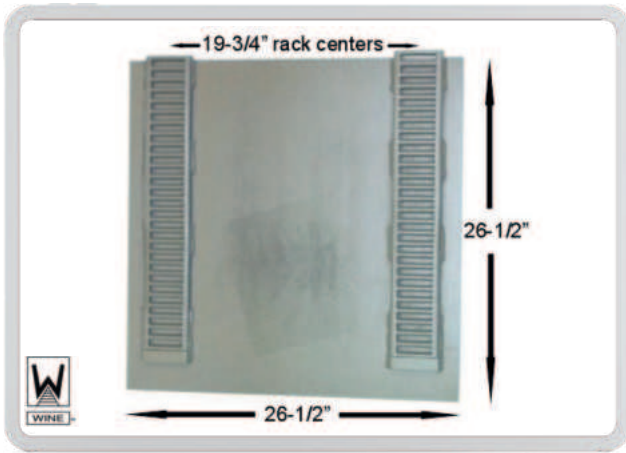

DA Pt # DA-41254
Alt Pt # 2CH-404
Description: Door Slide Assembly

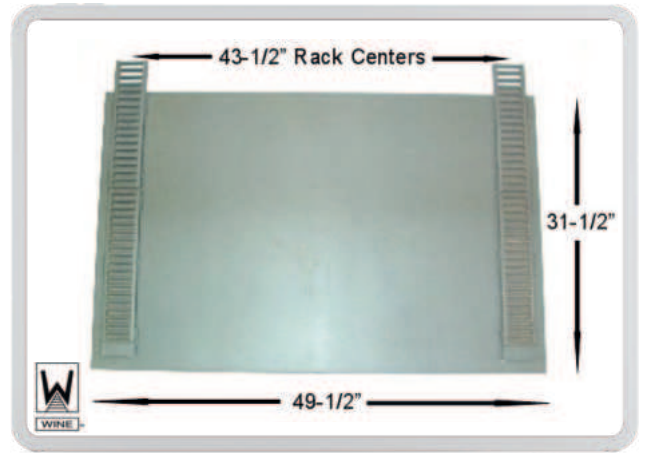

DA Pt # DA-41328
Alt Pt # 41328
Description: Door Slide Assembly

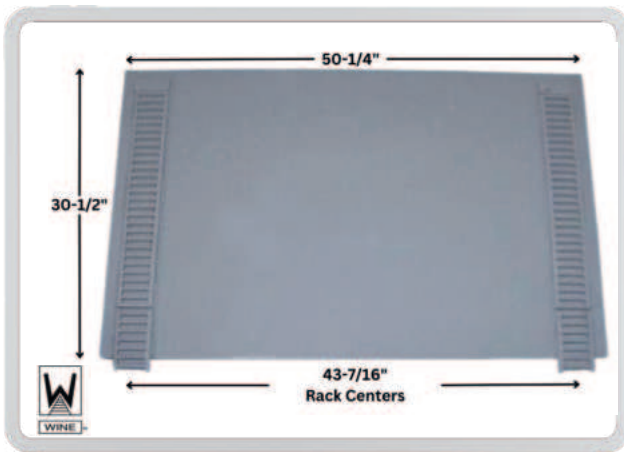

DA Pt # DA-41329
Alt Pt # 3CH-429
Description: Door Slide Assembly

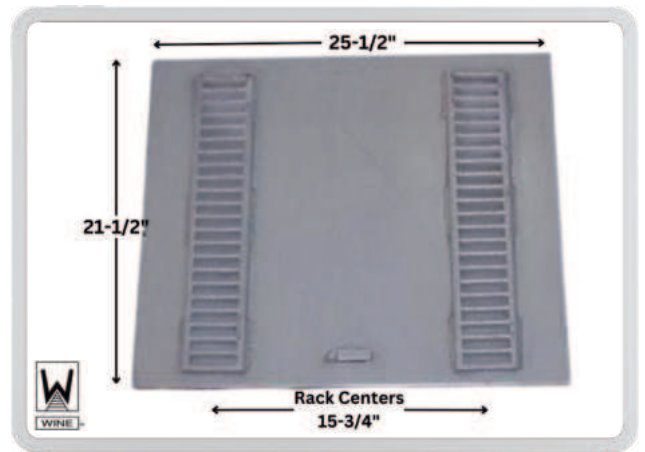

DA Pt # DA-61294
Alt Pt # 2CH-654-1
Description: Door Slide Assembly



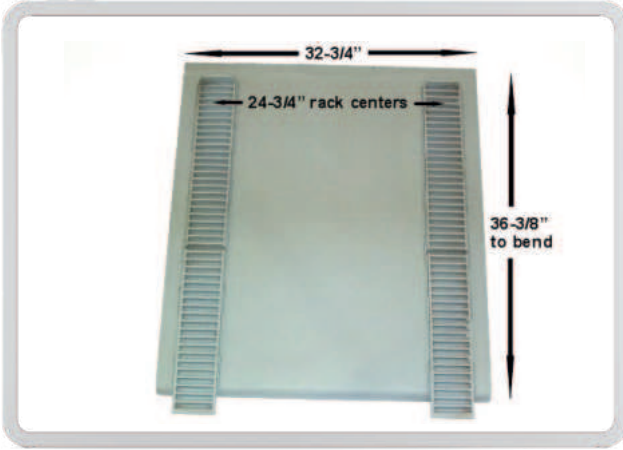

DA Pt # DA-07118
Alt Pt # DA-7118
Description: Door Slide Assembly

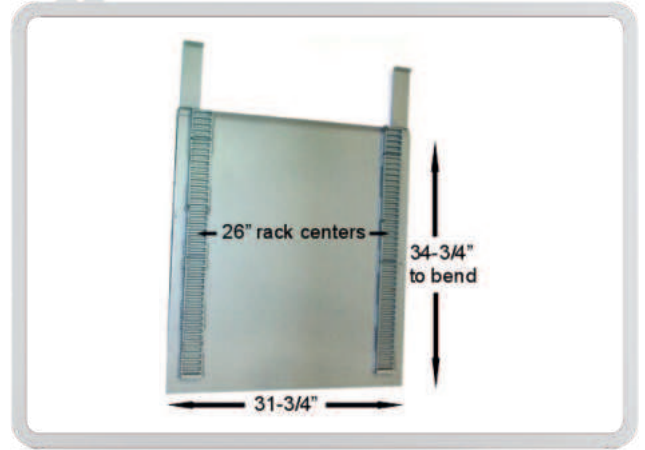

DA Pt # DA-07987
Alt Pt # DA-7987
Description: Door Slide Assembly

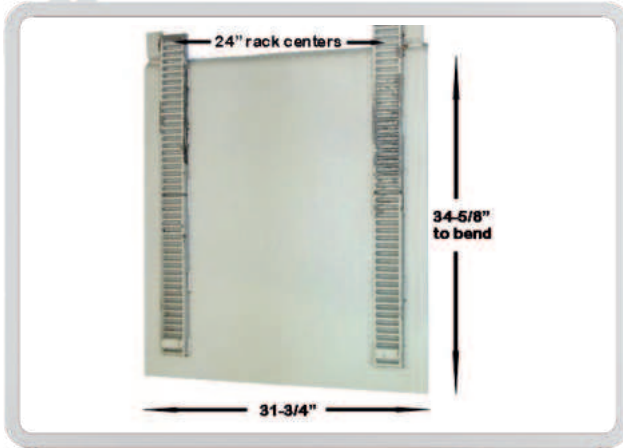

DA Pt # DA-08410
Alt Pt # 08410
Description: Door Slide Assembly

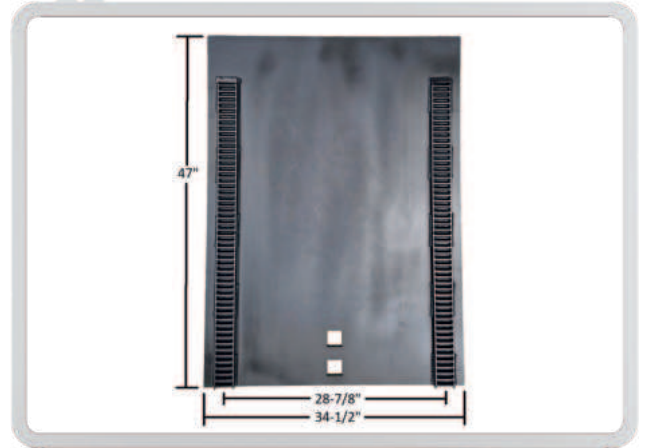

DA Pt # DA-10066
Alt Pt # 10066
Description: Door Slide Assembly

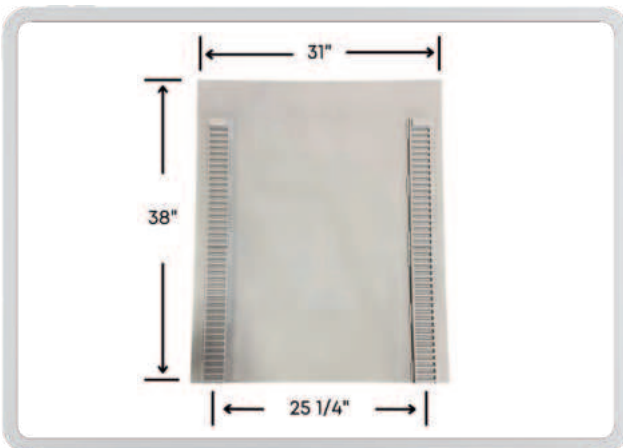

DA Pt # DA-10515
Alt Pt # 10515
Description: Door Slide Assembly



DA Pt # DA-00000
Alt Pt # 00000
Description: Wine Railcar Products

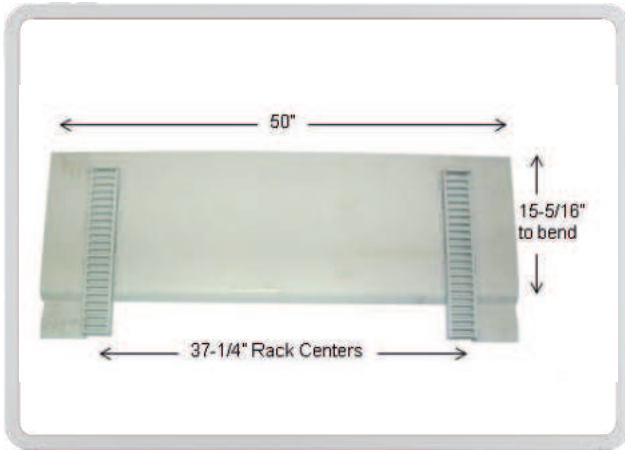

DA Pt # DA-11286
Alt Pt # 11286
Description: Door Slide Assembly

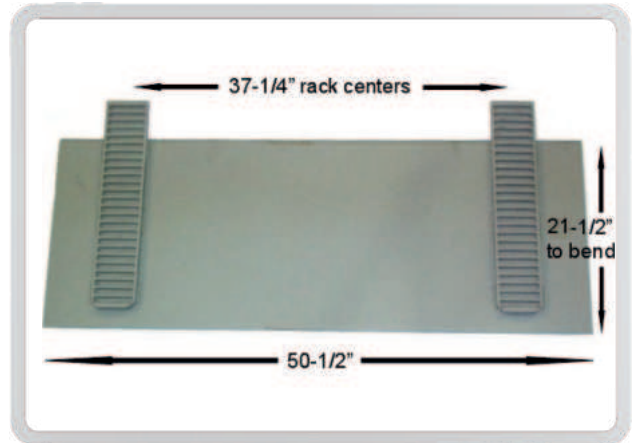

DA Pt # DA-50204
Alt Pt # 50204
Description: Door Slide Assembly

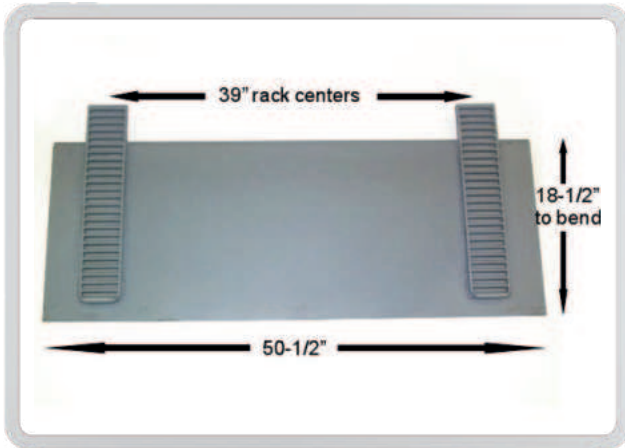

DA Pt # DA-50209
Alt Pt # 50209
Description: Door Slide Assembly

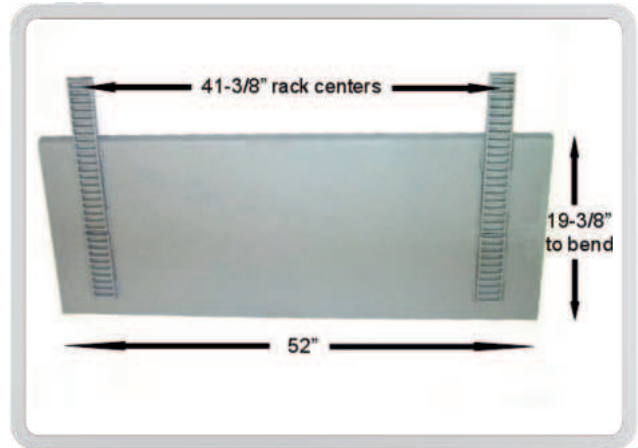

DA Pt # DA-50210
Alt Pt # 50210
Description: Door Slide Assembly

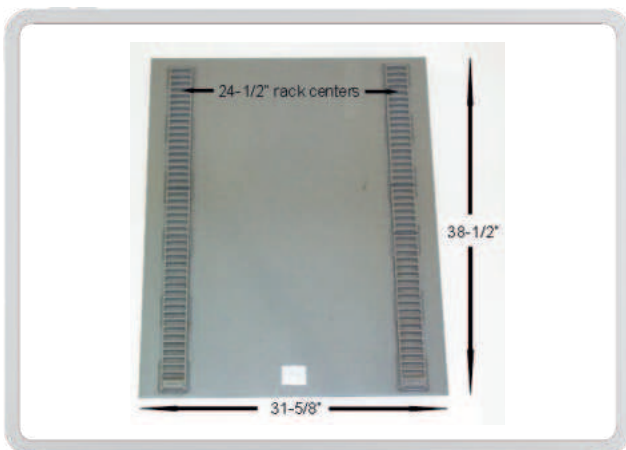

DA Pt # DA-10062
Alt Pt # MKE-10062
Description: Door Slide Assembly



DA Pt # DA-10070
Alt Pt # MKE10070
Description: Door Slide Assembly

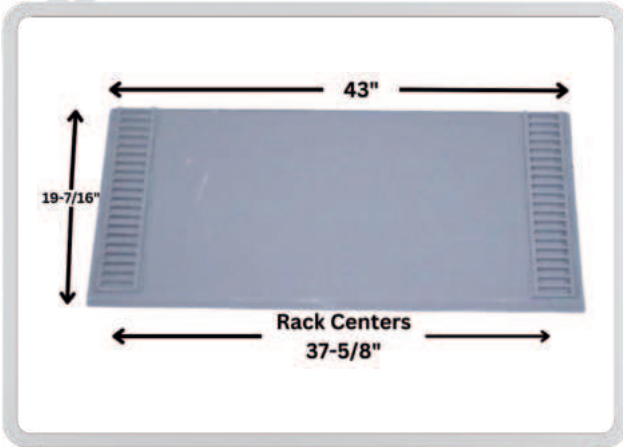

DA Pt # DA-05374
Alt Pt # Style #6
Description: Door Slide Assembly

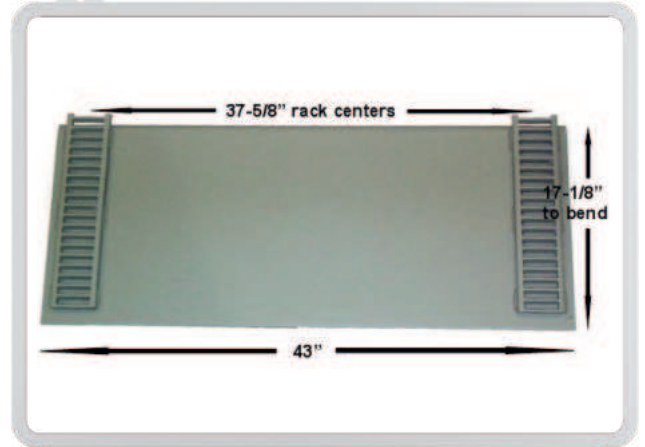

DA Pt # DA-05765
Alt Pt # Style #5
Description: Door Slide Assembly

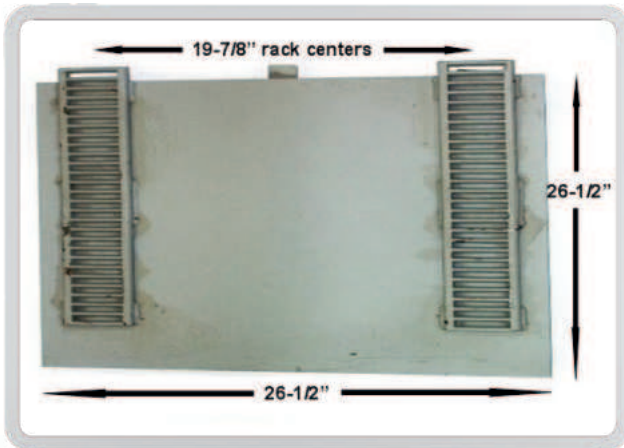

DA Pt # DA-05804
Alt Pt # Style # 4
Description: Door Slide Assembly

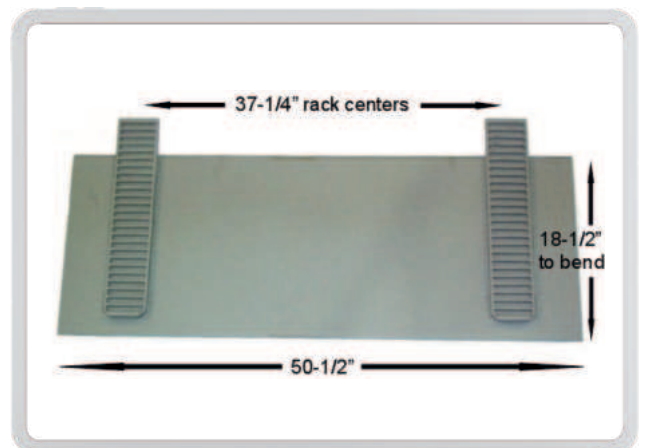

DA Pt # DA-50202
Alt Pt # Style #2
Description: Door Slide Assembly

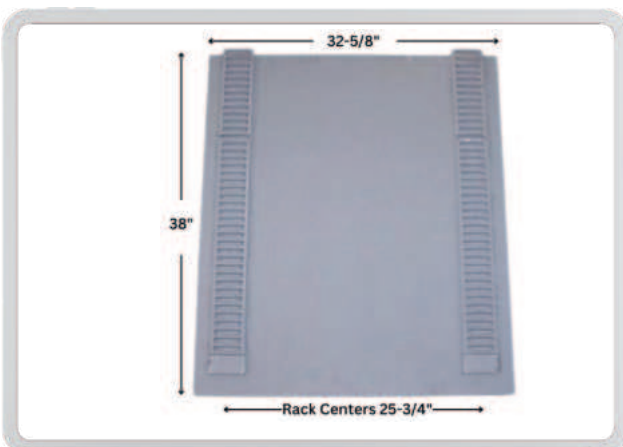

DA Pt # DA-50203
Alt Pt # Style #3
Description: Door Slide Assembly



DA Pt # DA-00000
Alt Pt # 00000
Description: Wine Railcar Products

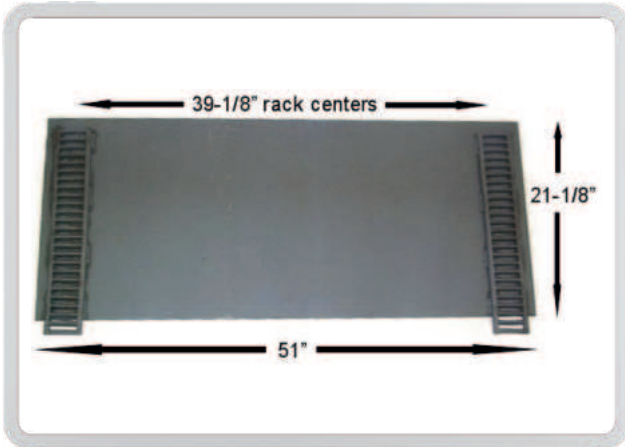

DA Pt # DA-63671
Alt Pt # 63671
Description: Door Slide Assembly



DA Pt # DA-30006
Alt Pt # 3000627
Description: Door Slide Assembly

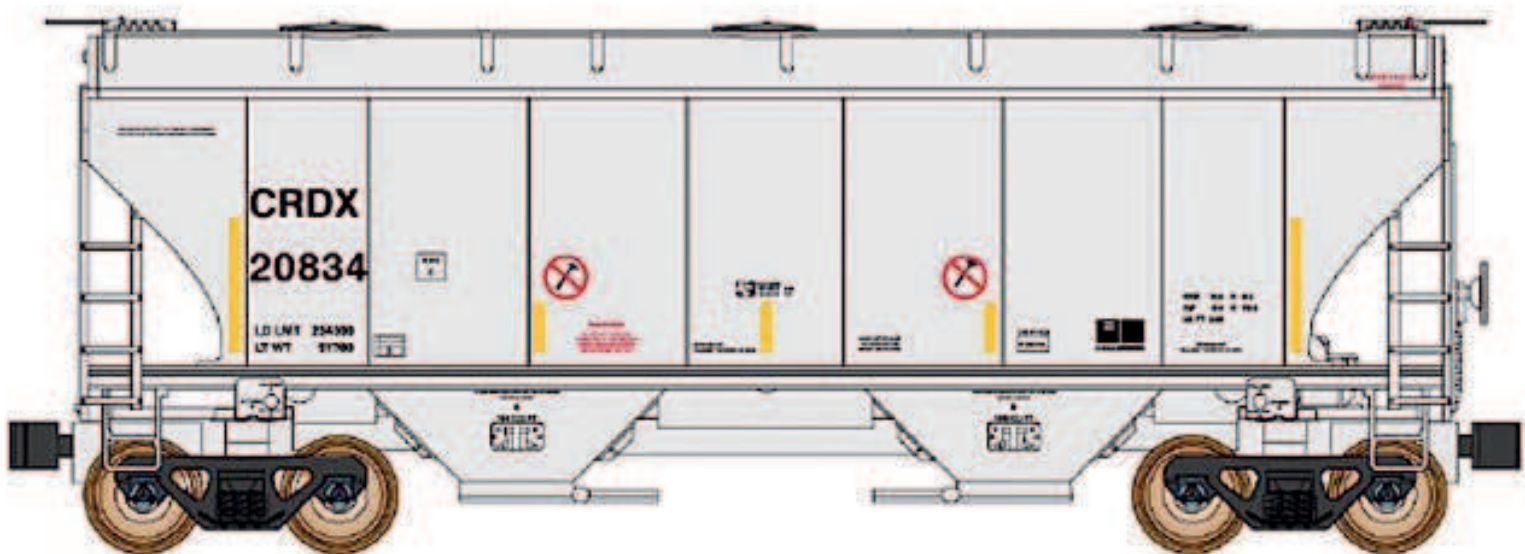



DA Pt # DA-60606
Alt Pt # PK-6
Description:
 Eccentric

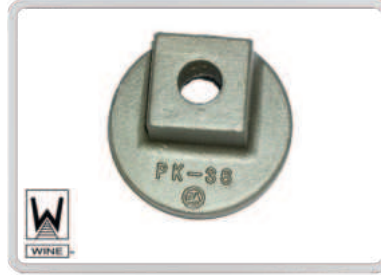

DA Pt # DA-31236
Alt Pt # PK-36
Description:
 Eccentric



DA Pt # DA-11900
Alt Pt # PC-119
Description:
 Eccentric

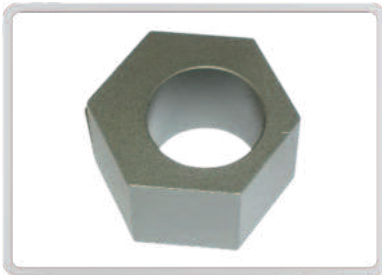

DA Pt # DA-50068
Alt Pt # 093-40049
Description:
 Eccentric Nut



DA Pt # DA-17025
Alt Pt # CL-25
Description:
 End Cap



DA Pt # DA-00000
Alt Pt # 000000
Description:
 Wine Railcar Products



DA Pt # DA-31818
Alt Pt # PK-318-A
Description:
 Extension



DA Pt # DA-31808
Alt Pt # PK-318-B
Description:
 Extension



DA Pt # DA-48908
Alt Pt # PK-489-A
Description:
 Extension



DA Pt # DA-48918
Alt Pt # PK-489-B
Description:
 Extension



DA Pt # DA-32101
Alt Pt # PK-321-A
Description:
 Extension



DA Pt # DA-32102
Alt Pt # PK-321-B
Description:
 Extension



DA Pt # DA-40431
Alt Pt # PK-431-A
Description:
 Extension



DA Pt # DA-41431
Alt Pt # PK-431-B
Description:
 Extension



DA Pt # DA-41454
Alt Pt # PK-454-A
Description:
 Extension



DA Pt # DA-42454
Alt Pt # PK-454-B
Description:
 Extension



DA Pt # DA-42457
Alt Pt # PK-457-A
Description:
 Extension



DA Pt # DA-43457
Alt Pt # PK-457-B
Description:
 Extension



DA Pt # DA-43487
Alt Pt # PK-487-A
Description:
 Extension



DA Pt # DA-44487
Alt Pt # PK-487-B
Description:
 Extension



DA Pt # DA-47134
Alt Pt # PK-471-A-34
Description:
 Extension



DA Pt # DA-47234
Alt Pt # PK-471-B-34
Description:
 Extension



DA Pt # DA-47487
Alt Pt # PK-487-AX
Description:
 Extension



DA Pt # DA-48487
Alt Pt # PK-487-BX
Description:
 Extensions



DA Pt # DA-48483
Alt Pt # PK-483-A
Description:
 Extension



DA Pt # DA-48493
Alt Pt # PK-483-B
Description:
 Extension



DA Pt # DA-42467
Alt Pt # MC-467
Description:
 Eyebolt Bracket



DA Pt # DA-43511
Alt Pt # MC-511
Description:
 Eyebolt Bracket



DA Pt # DA-31780
Alt Pt # B-31780
Description: 13/16" dia. holes
 Filler Casting



DA Pt # DA-28261
Alt Pt # PK-261-A
Description:
 Filler



DA Pt # DA-29261
Alt Pt # PK-261-B
Description:
 Filler



DA Pt # DA-12611
Alt Pt # PK-261-A-1
Description:
 Filler



DA Pt # DA-22611
Alt Pt # PK-261-B-1
Description:
 Filler



DA Pt # DA-04268
Alt Pt # T-130
Description:
 Fulcrum Bracket



DA Pt # DA-50030
Alt Pt # 093-40030
Description:
 Fulcrum Spring



DA Pt # DA-44839
Alt Pt # 44839
Description:
 Friction Shoe

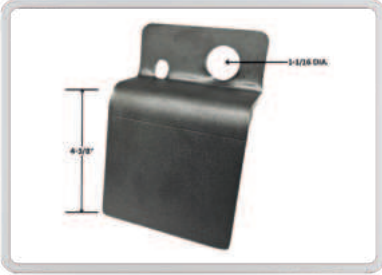

DA Pt # DA-28275-A
Alt Pt # 28275
Description:
 Gate Lock Bracket

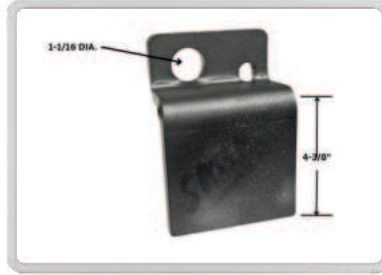

DA Pt # DA-28275-B
Alt Pt # 28275
Description:
 Gate Lock Bracket



DA Pt # DA-28273
Alt Pt # 28273
Description:
 Gate Lock End Piece

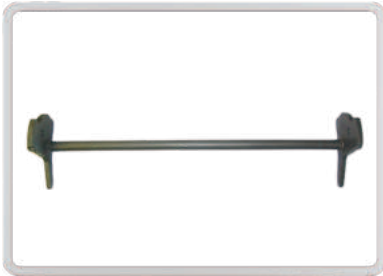

DA Pt # DA-28274
Alt Pt # 28274
Description:
 Gate Lock Bar Assembly



DA Pt # DA-30115
Alt Pt # 212-30115-LH
Description:
 Guide Finger for Rave Door



DA Pt # DA-30119
Alt Pt # 212-30119-LH
Description:
 Guide Finger for Rave Door



DA Pt # DA-81690
Alt Pt # DA-800040
Description:
 Hanger for Rave Door



DA Pt # DA-50300
Alt Pt # DA-503
Description:
 Handle, Stainless Steel



DA Pt # DA-50090
Alt Pt # MB-253-5090
Description:
 Headed Pin



DA Pt # DA-00000
Alt Pt # 000000
Description:
 Wine Railcar Products



DA Pt # DA-00000
Alt Pt # 00000
Description:
 Wine Railcar Products

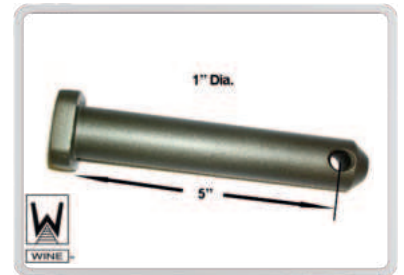

DA Pt # DA-12545
Alt Pt # DA-11746
Description:
 Hinge Pin



DA Pt # DA-14011
Alt Pt # 11140-11
Description:
 Hinge



DA Pt # DA-42499
Alt Pt # MC-499
Description:
 Hinge



DA Pt # DA-12130
Alt Pt # V-12130
Description:
 Hinge

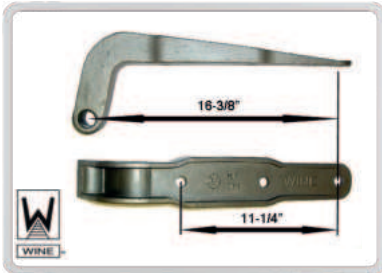

DA Pt # DA-23261
Alt Pt # HF-261
Description:
 Hinge, Substitutes DA-25127



DA Pt # DA-50092
Alt Pt # 093-40389
Description:
 Hinge



DA Pt # DA-50092-HD
Alt Pt # 1098746
Description:
 Hinge, Heavy Duty



DA Pt # DA-50016
Alt Pt # 093-40019
Description:
 Hinge

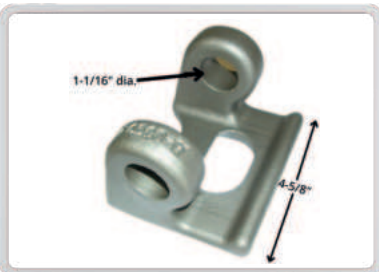

DA Pt # DA-50017
Alt Pt # 093-40020
Description:
 Hinge Butt



DA Pt # DA-14043
Alt Pt # UC-43
Description:
 Hinge Butt



DA Pt # DA-00000
Alt Pt # 00000
Description:
 Wine Railcar Products



DA Pt # DA-43512
Alt Pt # MC-512
Description:
 Hinge Butt



DA Pt # DA-40391
Alt Pt # 093-40391
Description:
 Hinge Butt



DA Pt # DA-30112
Alt Pt # 212-30112
Description:
 Hinge Leaf, Two Knuckle



DA Pt # DA-30113
Alt Pt # 212-30113
Description:
 Hinge Leaf, Three Knuckle

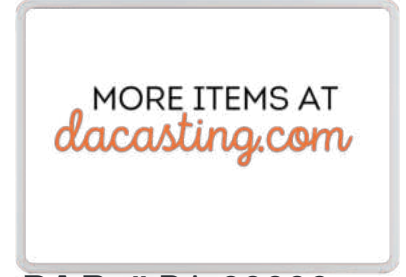

DA Pt # DA-00000
Alt Pt # 000000
Description:
 Wine Railcar Products



DA Pt # DA-22527
Alt Pt # PK-27-X
Description:
 Hook



DA Pt # DA-34234
Alt Pt # PK-342-34
Description:
 Hook



DA Pt # DA-48134
Alt Pt # PK-481-34
Description:
 Hook

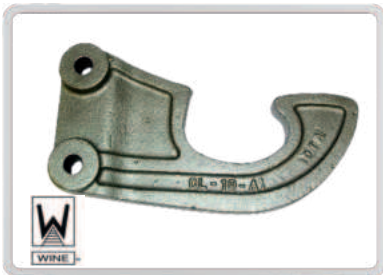

DA Pt # DA-17209
Alt Pt # CL-19-A
Description:
 Hook, Inner



DA Pt # DA-17219
Alt Pt # CL-19-B
Description:
 Hook, Inner



DA Pt # DA-17028
Alt Pt # CL-28
Description:
 Hook, Inner



DA Pt # DA-17503
Alt Pt # CL-13-A
Description:
 Hook, Inner



DA Pt # DA-17513
Alt Pt # CL-13-B
Description:
 Hook, Inner



DA Pt # 17160
Alt Pt # CL-60
Description:
 Hook, Inner



DA Pt # DA-17204
Alt Pt # CL-24-A
Description:
 Hook, Inner



DA Pt # DA-17224
Alt Pt # CL-24-B
Description:
 Hook, Inner



DA Pt # DA-17309
Alt Pt # CL-39-A
Description:
 Hook, Inner



DA Pt # DA-17339
Alt Pt # CL-39-B
Description:
 Hook, Inner



DA Pt # DA-17156
Alt Pt # CL-66-A
Description:
 Hook, Outer



DA Pt # DA-17166
Alt Pt # CL-66-B
Description:
 Hook, Outer



DA Pt # DA-17349
Alt Pt # CL-59-A
Description:
 Hook, Outer



DA Pt # DA-17359
Alt Pt # CL-59-B
Description:
 Hook, Outer



DA Pt # DA-17605
Alt Pt # CL-65-A
Description:
 Hook, Outer



DA Pt # DA-17665
Alt Pt # CL-65-B
Description:
 Hook, Outer



DA Pt # DA-17512
Alt Pt # CL-12-A
Description:
 Hook, Outer



DA Pt # DA-17612
Alt Pt # CL-12-B
Description:
 Hook, Outer



DA Pt # DA-28020
Alt Pt # CL-20-A
Description:
 Hook, Outer



DA Pt # DA-23527
Alt Pt # CL-27-A
Description:
 Hook, Outer



DA Pt # DA-17308
Alt Pt # CL-38-A
Description:
 Hook, Outer



DA Pt # DA-28120
Alt Pt # CL-20-B
Description:
 Hook, Outer

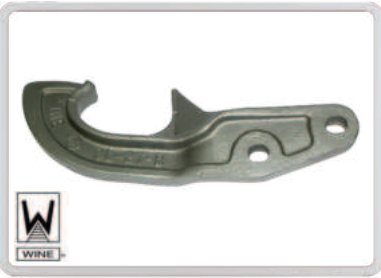

DA Pt # DA-23627
Alt Pt # CL-27-B
Description:
 Hook, Outer



DA Pt # DA-17338
Alt Pt # CL-38-B
Description:
 Hook, Outer





DA Pt # DA-17002
Alt Pt # D-170-7002
Description: Aluminum, LH
 Hopper Door for RD Car



DA Pt # DA-17003
Alt Pt # D-170-7003
Description: Aluminum, RH
 Hopper Door for RD Car

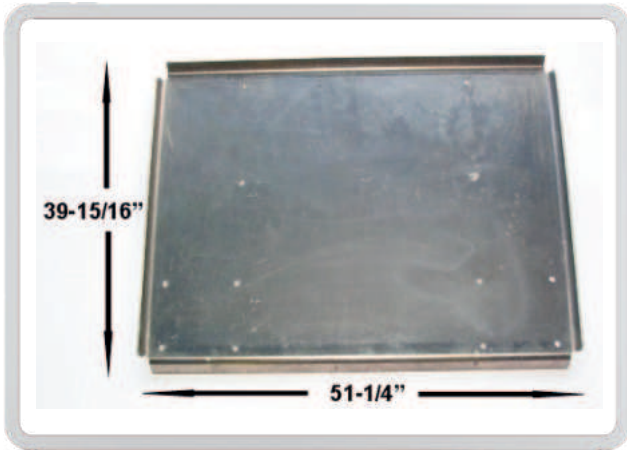

DA Pt # DA-17060
Alt Pt # D1706039
Description: Aluminum
 Hopper Door for RD Car



DA Pt # DA-00402
Alt Pt # 200402
Description: Aluminum, LH
 Hopper Door



DA Pt # DA-75793-1
Alt Pt # 75793-010
Description: Aluminum
 Hopper Door



DA Pt # DA-75793-2
Alt Pt # 75793-020
Description: Aluminum
 Hopper Door

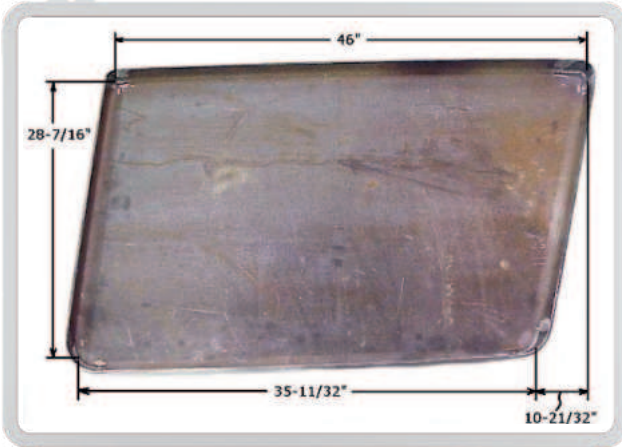

DA Pt # DA-76031
Alt Pt # 76031
Description: Trapezoidal, LH Hopper Door

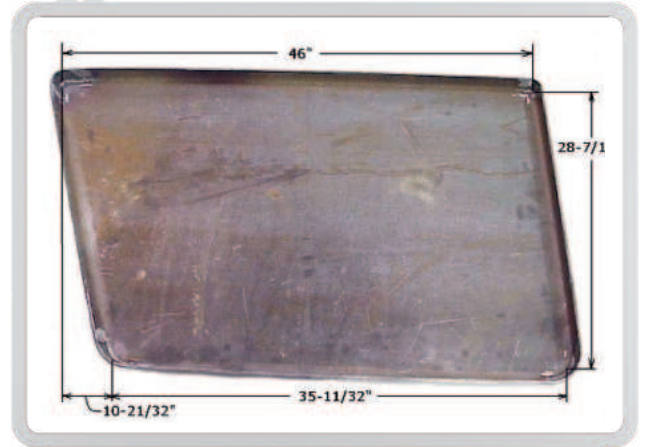

DA Pt # DA-76035
Alt Pt # 76035
Description: Trapezoidal, RH Hopper Door



DA Pt # DA-52966
Alt Pt # 810-691551
Description: Trapezoidal, LH Hopper Door

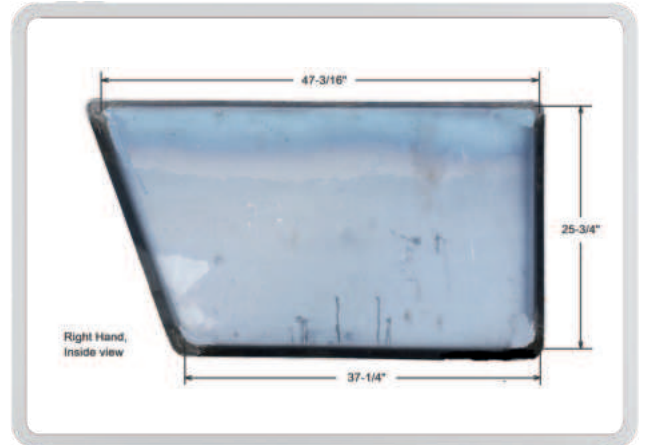

DA Pt # DA-52965
Alt Pt # 810-689671
Description: Trapezoidal, RH Hopper Door



DA Pt # DA-47008
Alt Pt # D-004-7008
Description: Inner Hopper Door for RD Car

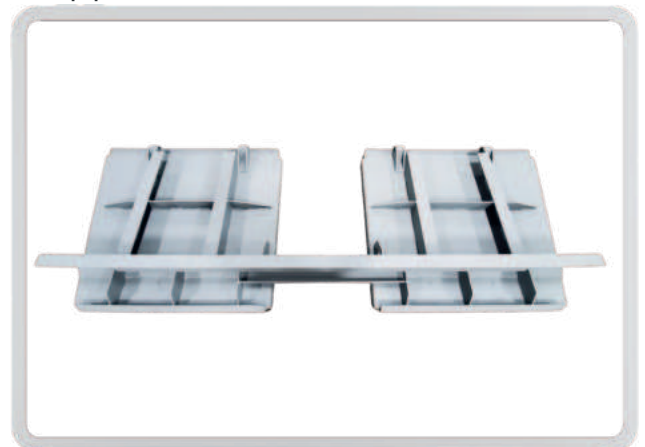

DA Pt # DA-47009
Alt Pt # D-004-7009
Description: Outer Hopper Door for RD Car

Conventional Open Top Hopper Doors

DA Hopper Door Part Number	Door Size	Lock Mounting Holes	Material Thickness	Material
DA-176003	Narrow	None	5/16"	Carbon Steel
DA-176003-CL	Narrow	WINE Cam Lock	5/16"	Carbon Steel
DA-176003-H	Narrow	WINE Spreader Beam	5/16"	Carbon Steel
DA-176005	Narrow	None	3/8"	Carbon Steel
DA-176005-H	Narrow	WINE Spreader Beam	3/8"	Carbon Steel
DA-76005	Narrow	None	1/4"	Stainless Steel
DA-76005-H	Narrow	WINE Spreader Beam	1/4"	Stainless teel
DA-176004	Wide	None	5/16"	Carbon Steel
DA-176004-CL	Wide	WINE Cam Lock	5/16"	Carbon Steel
DA-176004-SP	Wide	WINE Spreader Beam	5/16"	Carbon Steel
DA-176006	Wide	None	3/8"	Carbon Steel
DA-176006-H	Wide	WINE Spreader Beam	3/8"	Carbon Steel
DA-76006	Wide	None	1/4"	Stainless Steel
DA-76006-H	Wide	WINE Spreader Beam	1/4"	Stainless Steel
DA-176004-AL	Wide	None	1/4"	Aluminum

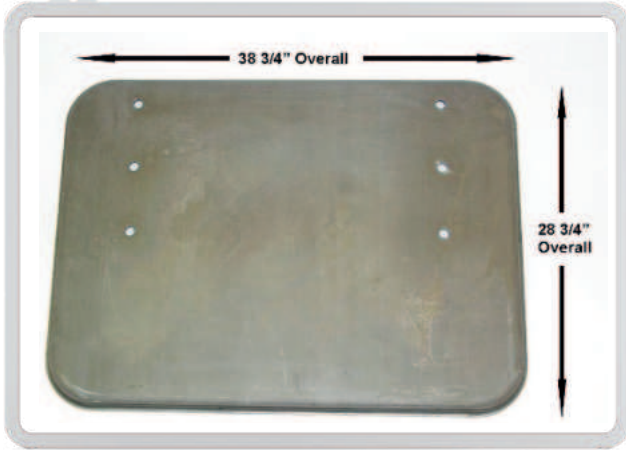

DA Pt # DA-176003
Alt Pt # D-170-6003
Description: Small Hopper Door

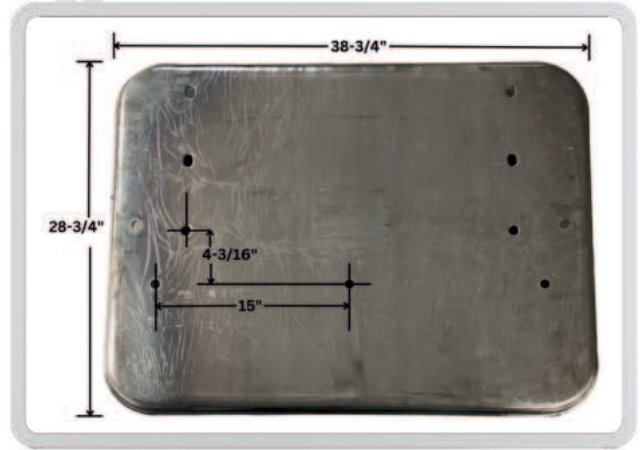

DA Pt # DA-176003-CL
Alt Pt # 176003CL
Description: Small, 5/16" Thick Hopper Door w/ Cam Lock Holes

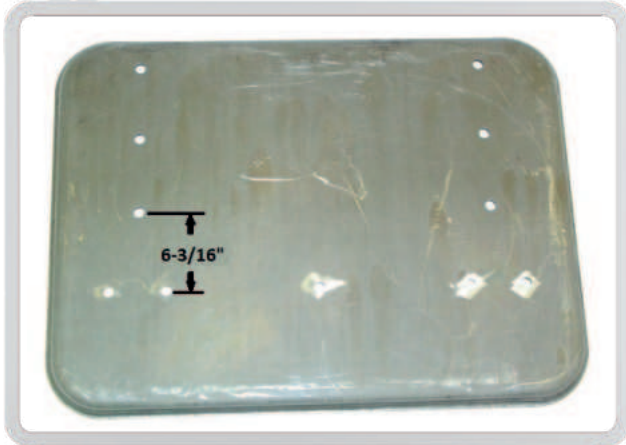

DA Pt # DA-176003-H
Alt Pt # 176003H
Description: Hopper Door w/ Spreader Beam Holes, Small, Carbon Steel, 5/16" Thick

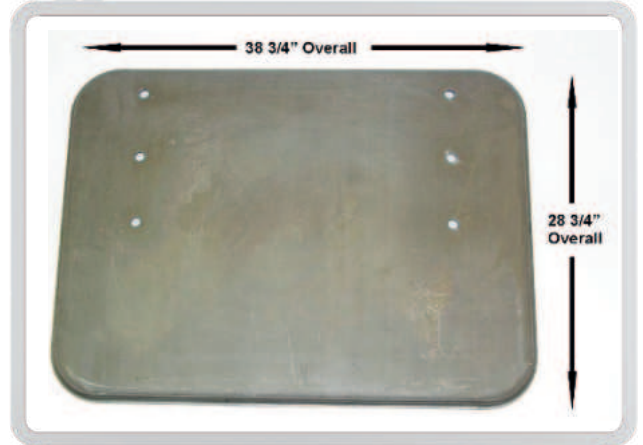

DA Pt # DA-176005
Alt Pt # 176005
Description: Small, Carbon Steel Hopper Door, 3/8" Thick

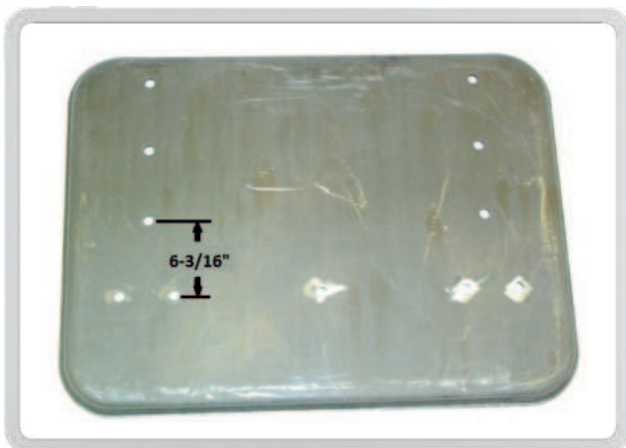

DA Pt # DA-176005-H
Alt Pt # 176005H
Description: Small, Carbon Steel Hopper Door, 3/8" Thick w/ Spreader Holes

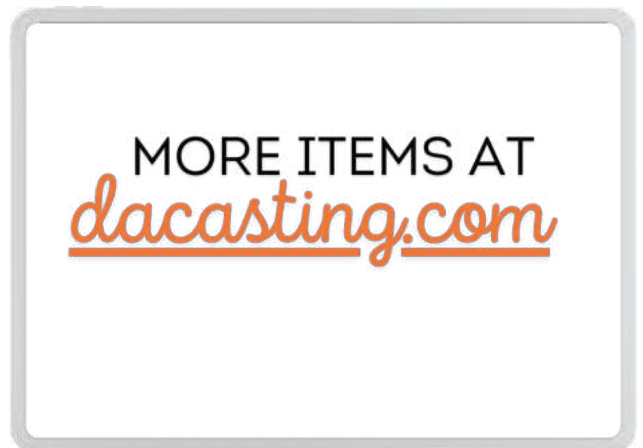

DA Pt # DA-00000
Alt Pt # 00000
Description: Wine Railcar Products

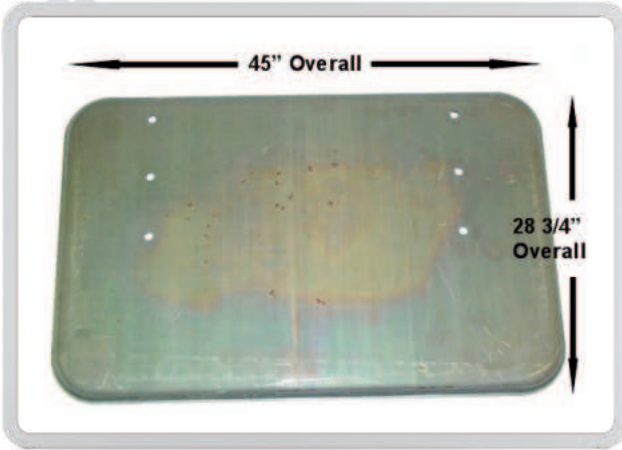

DA Pt # DA-176004
Alt Pt # D-170-6004
Description: Large Hopper Door

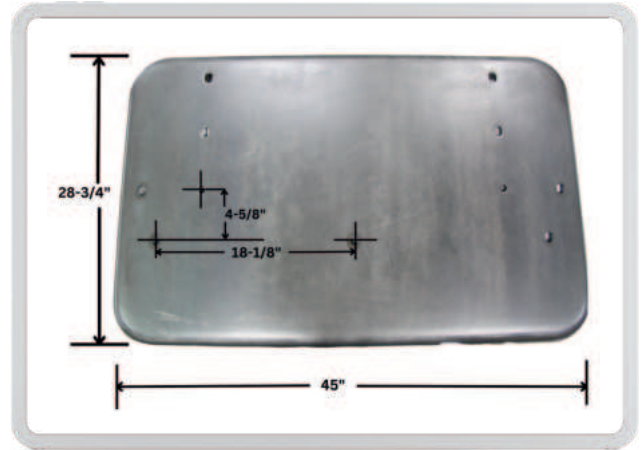

DA Pt # DA-176004-CL
Alt Pt # 176004CL
Description: Large, 5/16" Thick Hopper Door w/ Cam Lock Holes

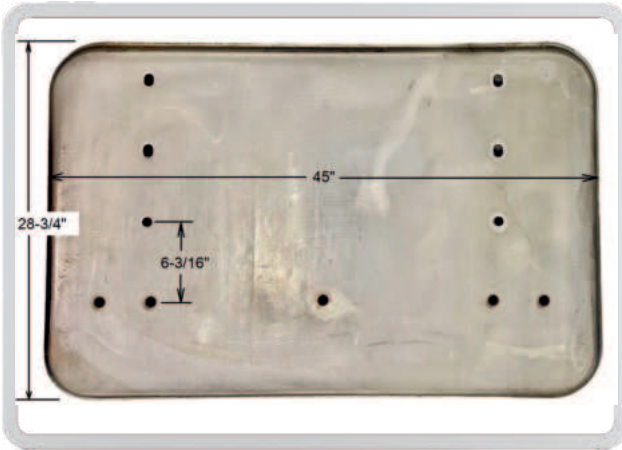

DA Pt # DA-176004-SP
Alt Pt # D-170-6004
Description: Large, Carbon Steel, 5/16" Thick Hopper Door w/ Spreader Beam Holes

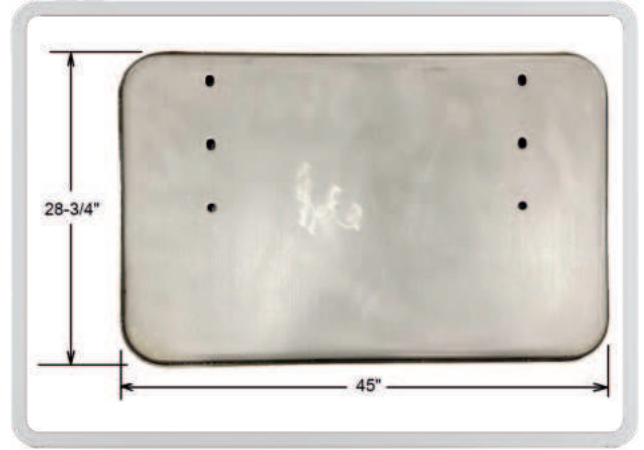

DA Pt # DA-176006
Alt Pt # 176006
Description: Large, Carbon Steel Hopper Door, Large, 3/8 inch Thick

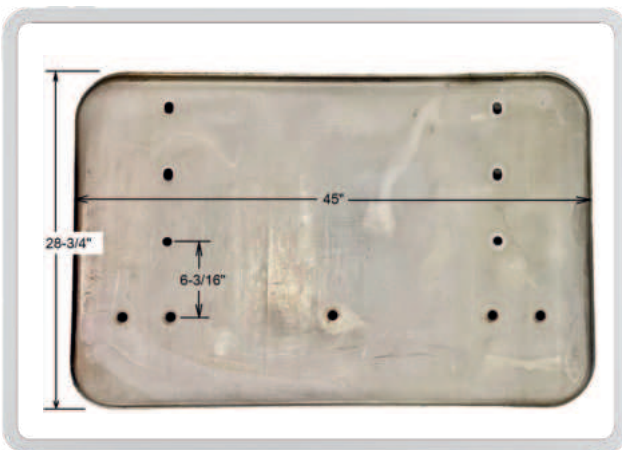

DA Pt # DA-176006-H
Alt Pt # 176006H
Description: Large, Carbon Steel Hopper Door, 3/8" Thick w/ Spreader holes

MORE ITEMS AT
dacasting.com

DA Pt # DA-00000
Alt Pt # 00000
Description: Wine Railcar Products

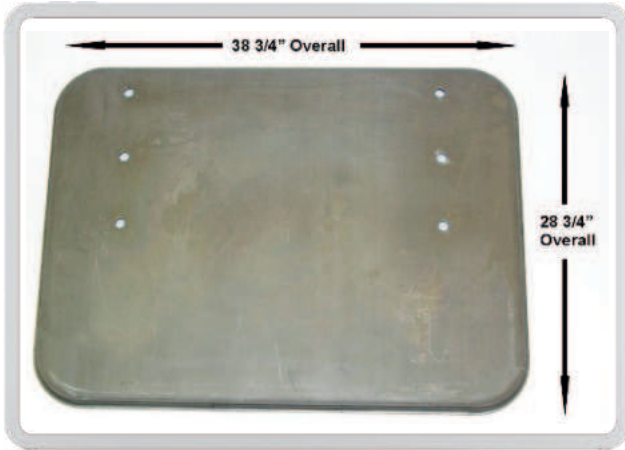

DA Pt # DA-76005
Alt Pt # D-170-6051
Description: Small, Stainless Steel Hopper Door, 1/4" Thick

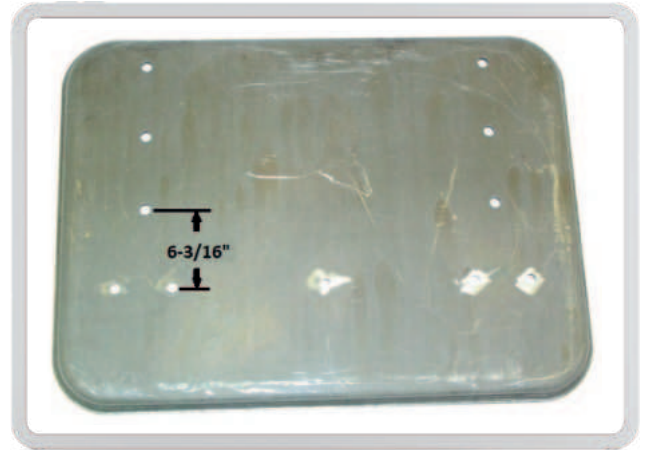

DA Pt # DA-76005-H
Alt Pt # 76005H
Description: Small, Carbon Steel Hopper Door, 3/8" Thick w/ Spreader Holes

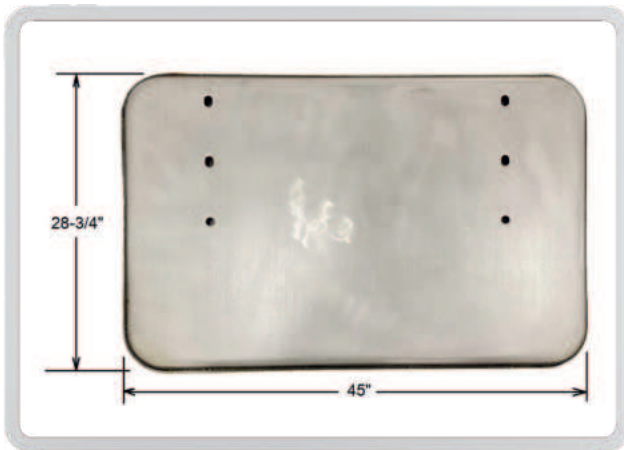

DA Pt # DA-76006
Alt Pt # 76006
Description: Large, Stainless Steel Hopper Door, 1/4" Thick

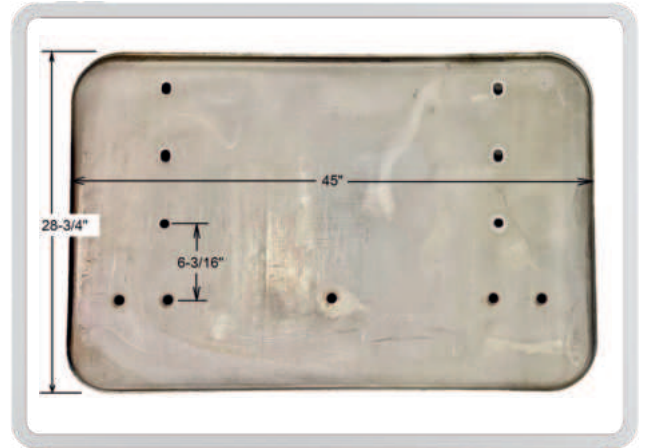

DA Pt # DA-76006-H
Alt Pt # 76006H
Description: Large, Stainless Steel Hopper Door, 1/4" Thick w/ Spreader Holes



DA Pt # DA-176004-AL
Alt Pt # 176004AL
Description: Large, Aluminum Hopper Door, 1/4" Thick

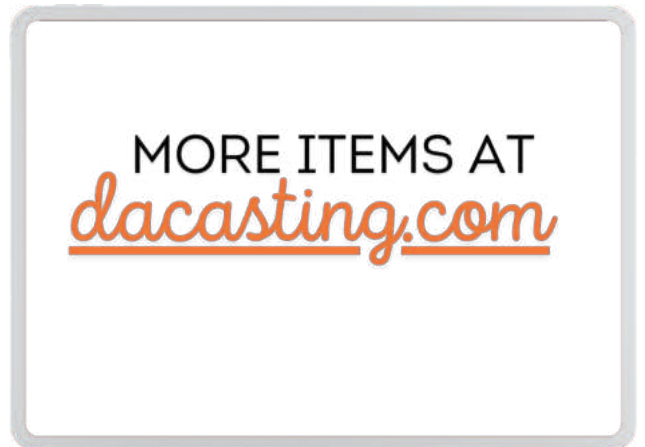

DA Pt # DA-00000
Alt Pt # 00000
Description: Wine Railcar Products



DA Pt # DA-25212
Alt Pt # HF-212-A
Description: 25-3/4 x 42, 30°
 Hopper Frame, Rectangular



DA Pt # DA-25213
Alt Pt # HF-212-B
Description: 25-3/4 x 42, 30°
 Hopper Frame, Rectangular



DA Pt # DA-25210
Alt Pt # HF-210-A
Description: 25-27/32 x 35-3/4, 45°
 Hopper Frame, Rectangular



DA Pt # DA-25211
Alt Pt # HF-210-B
Description: 25-27/32 x 35-3/4, 45°
 Hopper Frame, Rectangular



DA Pt # DA-18259
Alt Pt # HF-259-A-18
Description: Rectangle
 Hopper Frame



DA Pt # DA-18260
Alt Pt # HF-259-B-18
Description: Rectangle
 Hopper Frame



DA Pt # DA-10238
Alt Pt # HF-238-A-10
Description: 25-3/4 x 42, 45°
 Hopper Frame



DA Pt # DA-10239
Alt Pt # HF-238-B-10
Description: 25-3/4 x 42, 45°
 Hopper Frame

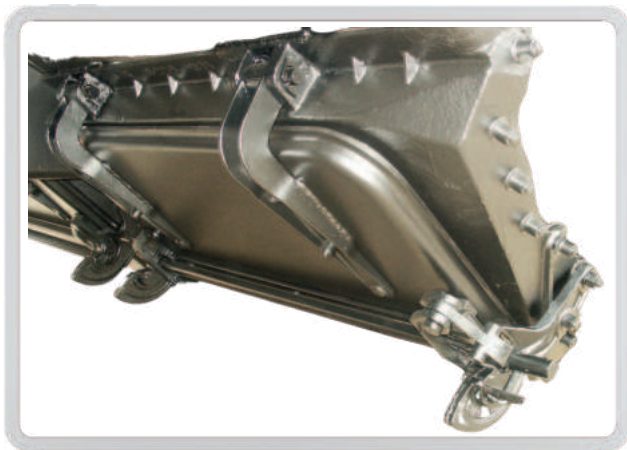

See pages 8 & 9 for complete list of
 parts for complete opening
 assembly

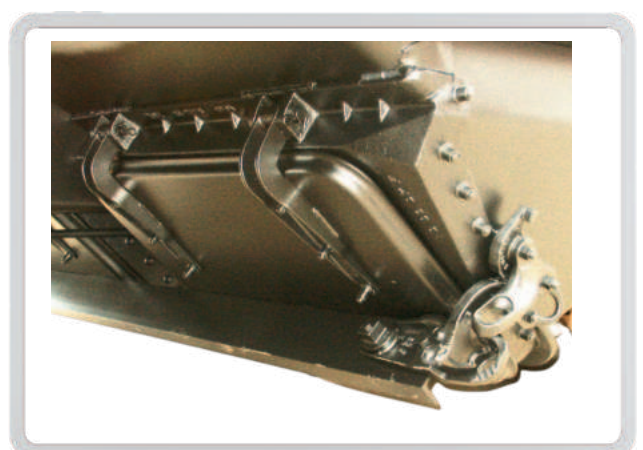

See Page 8 & 9 for complete list
 of parts for complete opening
 assembly



DA Pt # DA-20209
Alt Pt # 2CH-209
Description:
Latch



DA Pt # DA-12100
Alt Pt # PC-121
Description:
Latch



DA Pt # DA-15127
Alt Pt # 2CH-127-A
Description:
Latch Bracket



DA Pt # DA-15128
Alt Pt # 2CH-127-B
Description:
Latch Bracket



DA Pt # DA-11007
Alt Pt # PC-117
Description:
Latch Lug



DA Pt # DA-20210
Alt Pt # 2CH-210
Description:
Latch Retainer



DA Pt # DA-50044
Alt Pt # 093-40035
Description:
Lever End, Door Operating



DA Pt # DA-52090
Alt Pt # DA-500-LH
Description: Left Hand
Lock weld/seal pin bracket



DA Pt # DA-52101
Alt Pt # DA-501-RH
Description: RH, 2-1/4"
Lock weld/seal pin bracket



DA Pt # DA-50772
Alt Pt # 06772-LH
Description: Left Hand
Lock weld/seal pin bracket



DA Pt # DA-50773
Alt Pt # 06773-RH
Description: RH, 1-3/4"
Lock weld/seal pin bracket



DA Pt # DA-00000
Alt Pt # 000000
Description:
Wine Railcar Products



DA Pt # DA-50774
Alt Pt # 7043
Description: Left Hand
 Lock weld/seal pin bracket



DA Pt # DA-50775
Alt Pt # 7044
Description: RH, 2-1/16"
 Lock weld/seal pin bracket



DA Pt # DA-12003
Alt Pt # PC-123
Description:
 Locking Lever



DA Pt # DA-10082-A
Alt Pt # 10082A
Description: Short, Outside
 Lock Lift Follower



DA Pt # DA-10082-B
Alt Pt # 10082B
Description: Short
 Door Lock



DA Pt # DA-30651
Alt Pt # 930651
Description: 1/4" Thick
 L-Bracket



DA Pt # DA-10081-A
Alt Pt # 10081A
Description: Outside, Long
 Lock Lift Follower



DA Pt # DA-10081-B
Alt Pt # 10081B
Description: Short
 Lock for Door



DA Pt # DA-00000
Alt Pt # 00000
Description:
 Wine Railcar Products



DA Pt # DA-68845
Alt Pt # 204910055
Description:
 Outlet Gate Lock



DA Pt # DA-00000
Alt Pt # 000000
Description:
 Wine Railcar Products



DA Pt # DA-12000
Alt Pt # PC-120
Description:
 Outer Bearing



DA Pt # DA-17417
Alt Pt # CL-7
Description:
 Pawl



DA Pt # DA-28112
Alt Pt # PK-2-A
Description:
 Pawl



DA Pt # DA-29112
Alt Pt # PK-2-B
Description:
 Pawl



DA Pt # DA-32343
Alt Pt # PK-343-A
Description:
 Pawl



DA Pt # DA-34343
Alt Pt # PK-343-B
Description:
 Pawl



DA Pt # DA-43480
Alt Pt # PK-480-A
Description:
 Pawl



DA Pt # DA-44480
Alt Pt # PK-480-B
Description: Inner
 Pawl



DA Pt # DA-33178
Alt Pt # 2CH-328
Description: Outer
 Pinion Gear



DA Pt # DA-xxxxx
Alt Pt # xxxxx
Description: xxxx
 xxxxx



DA Pt # DA-92266
Alt Pt # MB-999-5186
Description:
 Plunger Nose



DA Pt # DA-42498
Alt Pt # MC-498
Description:
 Pipe Bracket



DA Pt # DA-00000
Alt Pt # 00000
Description:
 Wine Railcar Products

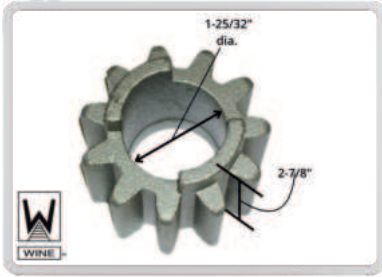

DA Pt # DA-21129
Alt Pt # 2CH-29
Description:
Pinion Gear



DA Pt # DA-69400
Alt Pt # 69400
Description: 1-3/4" Wide
Pinion Gear, 1-5/8" dia.

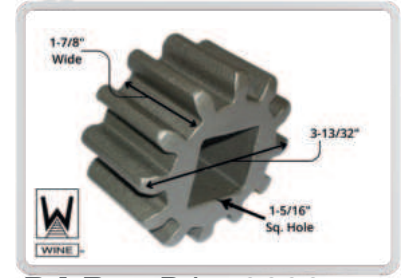

DA Pt # DA-70209
Alt Pt # DA-29-A
Description: 1-7/8" Wide
Pinion Gear, 1-5/16 Sq. Hole

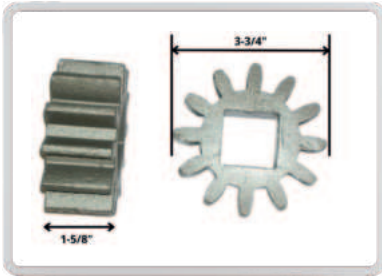

DA Pt # DA-70210
Alt Pt # DA-29-B
Description:
Pinion Gear

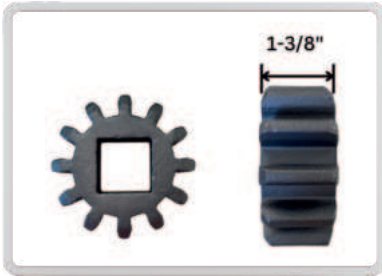

DA Pt # DA-70211
Alt Pt # 70211
Description:
Pinion, 1-3/8"

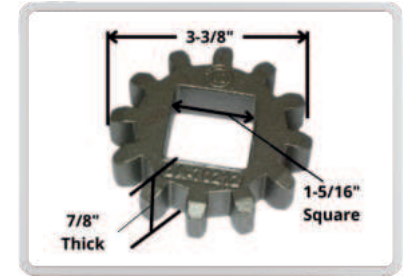

DA Pt # DA-70212
Alt Pt # 70212
Description:
Pinion Gear

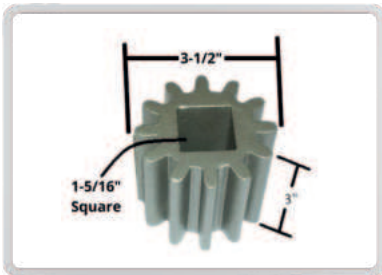

DA Pt # DA-52082
Alt Pt # DA-502
Description:
Pinion Gear

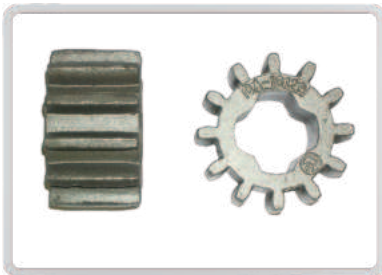

DA Pt # DA-10129
Alt Pt # 10129
Description:
Pinion Gear



DA Pt # DA-33179
Alt Pt # 2CH-327
Description:
Pinion Gear



DA Pt # DA-30304
Alt Pt # DA-502-SS
Description:
Pinion, Stainless Steel



DA Pt # DA-21130
Alt Pt # DA-29-304-SS
Description:
Pinion, Stainless Steel



DA Pt # DA-xxxxx
Alt Pt # xxxxx
Description: xxxx
xxxxx

Pinion Shafts



One end machined for capstan

DA Pt. #	Wine Pt #	Shaft Length	Shaft Diameter
DA-21934	1CH-409-1	30.75"	1-3/4"
DA-41051	1CH-409	30.5"	1-3/4"
DA-42010	1CH-409-10	30"	1-3/4"



Both ends machined for capstan

DA Pt. #	Wine Pt #	Shaft Length	Shaft Diameter
DA-31001	1CH-340-1	38.375"	1-3/4"
DA-31018	1CH-340-18	40.5"	1-3/4"
DA-31033	1CH-340-3	61"	1-3/4"
DA-33026	1CH-340-16	66"	1-3/4"
DA-34005	1CH-340-5	53"	1-3/4"
DA-34805	1CH-340-13	60.5"	1-3/4"



Square pinion shaft

DA Pt. #	Alt Pt. #	Shaft Length	Shaft Diameter
DA-01723	01723	36-3/8"	1-3/4"
DA-01733	01733	33"	1-3/4"
DA-07177	07177	65"	1-3/4"
DA-07248	07248	48"	1-3/4"

Alternate Sizes Available

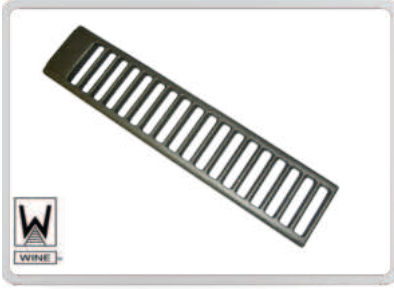

DA Pt # DA-13096
Alt Pt # 2CH-156
Description: 17-1/4" L
 Rack

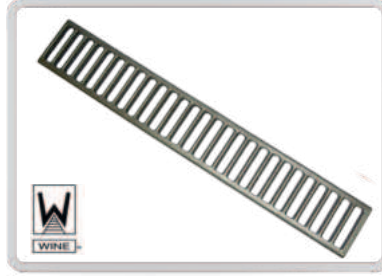

DA Pt # DA-33181
Alt Pt # 2CH-331
Description: 23-11/16" L
 Rack



DA Pt # DA-70213
Alt Pt # 70213
Description:
 Rack



DA Pt # DA-42339
Alt Pt # DA-4029
Description: 16-3/8" L
 Rack, 2-3/4" Wide



DA Pt # DA-42340
Alt Pt # DA-4030
Description: 20-1/2" L
 Rack, 2-3/4" Wide



DA Pt # DA-42328
Alt Pt # DA-7028
Description: 16-1/2" L
 Rack, 2-5/8" Wide

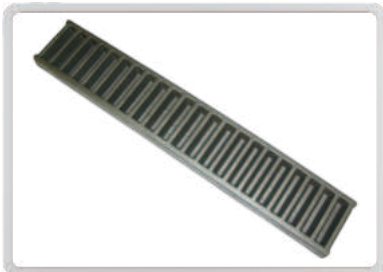

DA Pt # DA-41423
Alt Pt # DA-423
Description: 17-1/2" L
 Rack, 3" Wide

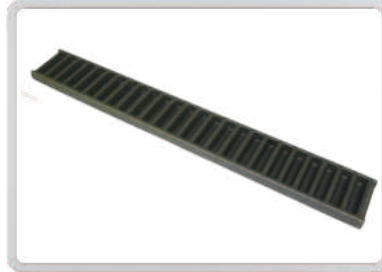

DA Pt # DA-10111
Alt Pt # 10111
Description: 20-9/32" L
 Rack



DA Pt # DA-00185
Alt Pt # 10085-2
Description:
 Rack



DA Pt # DA-00000
Alt Pt # 00000
Description:
 Wine Railcar Products



DA Pt # DA-42382
Alt Pt # VPA-6182
Description: 33-3/4" L
 Rack, 3-1/4" Wide



DA Pt # DA-00000
Alt Pt # 00000
Description:
 Wine Railcar Products



DA Pt # DA-42372
Alt Pt # DA-422
Description: 20-1/2" L
 Rack, 4-1/4" Wide

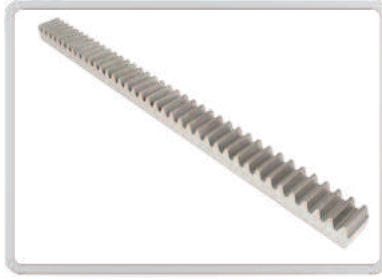

DA Pt # DA-50094
Alt Pt # 50094
Description: 30-5/8" L
 Rack

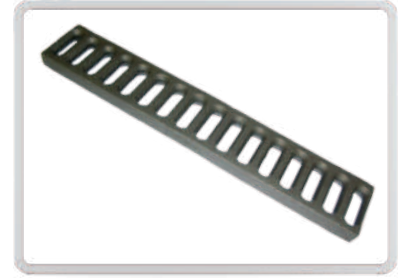

DA Pt # DA-42444
Alt Pt # 955002
Description: 18" Length
 Rack

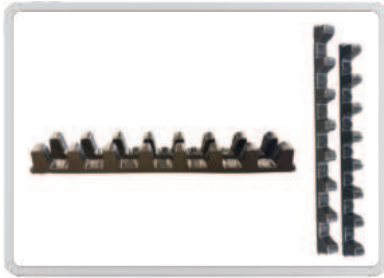

DA Pt # DA-70215
Alt Pt # 70215
Description:
 Rack



DA Pt # DA-00000
Alt Pt # 00000
Description:
 Wine Railcar Products





DA Pt # DA-00640
Alt Pt # RR-640
Description: Narrow Door
Rapid Release Cam Lock Ass'y



DA Pt # DA-00640-1
Alt Pt # RR-640-1
Description: Narrow Door
Rapid Release Cam Lock Ass'y



DA Pt # DA-00642
Alt Pt # RR-642
Description: Wide Door
Rapid Release Cam Lock Ass'y



DA Pt # DA-00642-1
Alt Pt # RR-642-1
Description: Wide Door
Rapid Release Cam Lock Ass'y

See Rapid Release Assembly Page 10

DACASTING.COM

Latest News at D.A.

DA Pt # DA-00000
Alt Pt # 00000
Description:
Wine Railcar Products



DA Pt # DA-00611
Alt Pt # RR-611-L
Description: LH
Rapid Release Hook



DA Pt # DA-00612
Alt Pt # RR-611-R
Description: RH
Rapid Release Hook



DA Pt # DA-00651
Alt Pt # RR-651-L
Description: LH
Rapid Release Hook



DA Pt # DA-00652
Alt Pt # RR-651-R
Description: RH
Rapid Release Hook



DA Pt # DA-00659
Alt Pt # RR-659-L
Description: LH
Rapid Release Hook



DA Pt # DA-00660
Alt Pt # RR-659-R
Description: RH,
Rapid Release Hook



DA Pt # DA-16966
Alt Pt # E-16096-B
Description:
 Striker Assembly



DA Pt # DA-30001
Alt Pt # 30001
Description:
 Striker Assembly



DA Pt # DA-14100
Alt Pt # D-10410-C
Description:
 Striker Assembly



DA Pt # DA-33505
Alt Pt # 3505-A
Description:
 Truck Damp



DA Pt # DA-00403
Alt Pt # 200403
Description: Z-Shaped
 Spreader Beam, Aluminum



DA Pt # DA-32272
Alt Pt # M-336-5072
Description: 5th wheel
 Release Handle



DA Pt. #	Alt Pt. #	Dimensions
DA-10991	10991	6" x 94.375"
DA-10992	10992	6" x 99"
DA-10993	10993	6" x 97.75"
DA-10994	10994	6" x 101.75"
DA-10996	490562-0	6" x 102.375"

See Complete Spring Assist Assembly Page 7



DA Pt # DA-50070
Alt Pt # 093-40051
Description:
 Lug for Spring Assist



DA Pt # DA-43279
Alt Pt # 43279
Description:
 Seal Cam Assembly



DA Pt # DA-50030
Alt Pt # 093-40030
Description:
 Fulcrum Spring



DA Pt # DA-50069
Alt Pt # 093-40050
Description:
 Spring Assembly Bracket



DA Pt # DA-50039
Alt Pt # 093-40028
Description:
 Spring Guide



DA Pt # DA-50034
Alt Pt # 50034
Description:
 Spring Guide Adj. Plate



DA Pt # DA-09048
Alt Pt # 50067
Description:
 Spring Guide and Stop



DA Pt # DA-50040
Alt Pt # 093-40029
Description:
 Spring Guide Bracket



DA Pt # DA-14123
Alt Pt # 131-40123
Description: Spring
 Spring for Spring Assist



DA Pt # DA-50038
Alt Pt # 131-40121
Description:
 Spring for Spring Assist



DA Pt # DA-50066
Alt Pt # 093-40047
Description:
 Spring Guide Bracket Cap



DA Pt # DA-50000-G

Alt Pt # 50000G

Description: Compressed Spring Assist Assembly #1

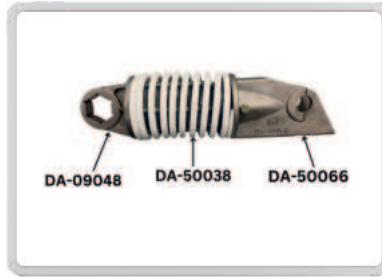

DA Pt # DA-50000-W

Alt Pt # 50000W

Description: Compressed Spring Assist Assembly #1



DA Pt # DA-33605

Alt Pt # PK-35

Description: Trunnion Washer

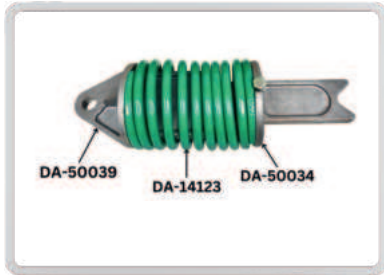

DA Pt # DA-50002-G

Alt Pt # 50002G

Description: Compressed Spring Assist Assembly #2

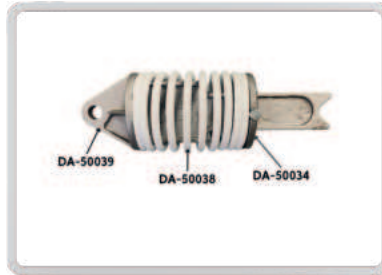

DA Pt # DA-50002-W

Alt Pt # 50002W

Description: Compressed Spring Assist Assembly #2

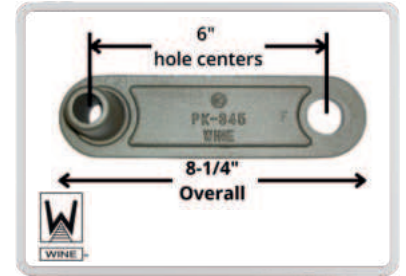

DA Pt # DA-37345

Alt Pt # PK-345

Description: Trunnion Washer

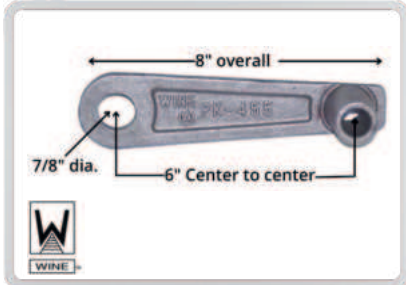

DA Pt # DA-43455

Alt Pt # PK-455

Description: Trunnion Washer



DA Pt # DA-11222

Alt Pt # 11222

Description: Vibrator Bracket



DA Pt # DA-11224

Alt Pt # 11224

Description: Vibrator Bracket



DA Pt # DA-01710

Alt Pt # M-167-5000

Description: Bolt on Vibrator Bracket



DA Pt # DA-01711

Alt Pt # M-167-6000

Description: Weld on Vibrator Bracket



DA Pt # DA-23193

Alt Pt # 023193-0

Description: Wedge Lock Assembly

Box Car Index

	D.A. Pt #	Alt Pt #	Description	Weight	Pg #	
A	DA-59411	029411	Adjustable Crankshaft 304SS	1.3	70	
	DA-56278	006278	Adjustable Rod End	3.3	70	
	DA-57595	027595	Anti Kick Back Pawl, Inner	0.8	70	
	DA-57596	027596	Anti Kick Back Pawl, Outer	2.1	70	
B	DA-58326	058326	Bottom Crank & Extension, 5-5/16"	15.2	70	
	DA-60169	060169	Bottom Crank Extension, 6-1/8"	15.5	70	
	DA-56381	056381	Bracket, Auxilliary Lock Sill	1.0	70	
	DA-53229	053229	Bracket, Lock Post	0.8	70	
C	DA-50562	053562	Cam, Lower Operating	1.3	70	
	DA-53559	053559	Cam, Operating	0.4	70	
	DA-59200	059200	Cam,Upper Operating	1.3	70	
	DA-58992	028992	Cam, Seal Cam Casting	1.80	70	
	DA-58330	038330	Clevis Casting	2.0	71	
	DA-53181	063181	Connector Clevis	2.8	71	
D	DA-58030	58030	Door Stop	6.9	71	
G H	DA-53548	010892	Gear	13.5	71	
	DA-57029	057029	Handle Casting	7.2	71	
	DA-53802	53802	Hasp Body & End, 2pc Kit	4.30	71	
	DA-53800	005155	Hasp, Body	4.1	71	
	DA-53801	005157	Hasp, End	0.2	71	
	DA-55159	005159	Hasp, Lock	4.3	71	
	DA-54494	041494	Hold Open Arm	0.9	71	
	L	DA-53555	053555	Lever Adapter	0.7	71
		DA-57687	027687	Lock Side Bolt	3.0	71
		DA-58978	028978	Lock Wedge Assembly	14.8	72
DA-58979		028979	Lock Wedge Assembly	14.7	72	
DA-58980		028980	Lock Wedge Assembly	14.9	72	
P	DA-57715	027715	Pipe Bottom Extension	6.6	72	
R	DA-34175	005463	Ratchet Pawl	0.9	72	
	DA-57650	027650	Ratchet Pawl	1.0	72	
	DA-57400	027400	Rod End Casting	1.0	72	
	DA-52340	002340	Roller Assembly	3.6	72	
	DA-57385-1	027349	Roller Housing w/ Hook, Primed	14.0	72	
	DA-50498-1	050498	Roller Housing w/o Hook, Primed	13.0	72	
	DA-57382	027382	Roller Stop Casting	2.40	72	
	DA-43279	43279	Seal Cam Casting	1.5	72	

This page was left blank intentionally



DA Pt # DA-59411
Alt Pt # 029411
Description:
Adjustable Crankshaft



DA Pt # DA-56278
Alt Pt # 006278
Description:
Adjustable Rod End



DA Pt # DA-57595
Alt Pt # 027595
Description: Inner
Anti Kick Back Pawl



DA Pt # DA-57596
Alt Pt # 027596
Description: Outer
Anti Kick Back Pawl



DA Pt # DA-58326
Alt Pt # 58326
Description: 5-5/16"
Bottom Crank & Extension



DA Pt # DA-60169
Alt Pt # 60169
Description: 6-1/8"
Bottom Crank & Extension



DA Pt # DA-56381
Alt Pt # 056381
Description:
Bracket, Auxiliary Lock Sill



DA Pt # DA-53229
Alt Pt # 053229
Description:
Bracket, Lock Post



DA Pt # DA-50562
Alt Pt # 053565
Description:
Cam, Lower Operating



DA Pt # DA-53559
Alt Pt # 053559
Description:
Cam, Operating



DA Pt # DA-59200
Alt Pt # 059200
Description:
Cam, Upper Operating



DA Pt # DA-58992
Alt Pt # 028992
Description:
Cam, Seal Cam Casting



DA Pt # DA-58330
Alt Pt # 038330
Description:
Clevis Casting



DA Pt # DA-53181
Alt Pt # 063181
Description:
Connector Clevis



DA Pt # DA-58030
Alt Pt # 058030
Description:
Door Stop



DA Pt # DA-53548
Alt Pt # 010892
Description:
Gear



DA Pt # DA-57029
Alt Pt # 057029
Description:
Handle Casting



DA Pt # DA-53802
Alt Pt # 53802
Description: 2pc Kit
Hasp Body & End



DA Pt # DA-53800
Alt Pt # 005155
Description:
Hasp, Body



DA Pt # DA-53801
Alt Pt # 005157
Description:
Hasp, End



DA Pt # DA-55159
Alt Pt # 005159
Description:
Hasp, Lock



DA Pt # DA-54494
Alt Pt # 041494
Description:
Hold Open Arm



DA Pt # DA-53555
Alt Pt # 053555
Description:
Lever Adapter



DA Pt # DA-57687
Alt Pt # 027687
Description:
Lock Side Bolt



DA Pt # DA-58978
Alt Pt # 028978
Description:
Lock Wedge Assembly

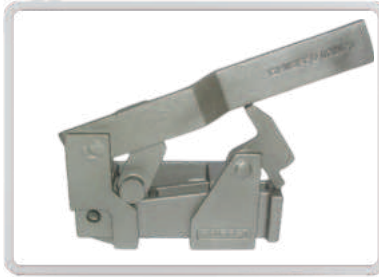

DA Pt # DA-58979
Alt Pt # 028979
Description:
Lock Wedge Assembly



DA Pt # DA-58980
Alt Pt # 028980
Description:
Lock Wedge Assembly

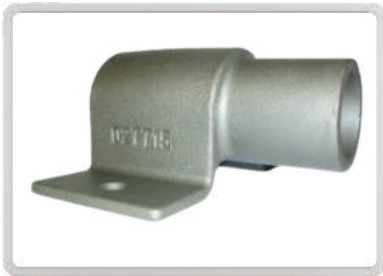

DA Pt # DA-57715
Alt Pt # 027715
Description:
Pipe Bottom Extension



DA Pt # DA-34175
Alt Pt # 005463
Description:
Ratchet Pawl



DA Pt # DA-57650
Alt Pt # 027650
Description:
Ratchet Pawl



DA Pt # DA-57400
Alt Pt # 027400
Description:
Rod End Casting



DA Pt # DA-52340
Alt Pt # 002340
Description:
Roller Assembly



DA Pt # DA-57385-1
Alt Pt # 027349
Description:
Roller Housing w/ Hook



DA Pt # DA-50498-1
Alt Pt # 050498
Description:
Roller Housing w/o Hook



DA Pt # DA-57382
Alt Pt # 027382
Description:
Roller Stop Casting



DA Pt # DA-43279
Alt Pt # 43279
Description:
Seal Cam Assembly

Bus Bar Clamps

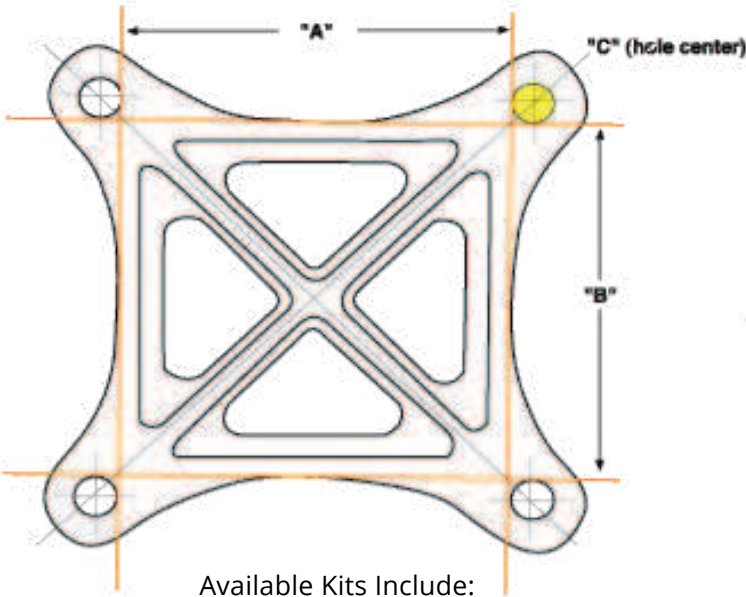

Available Kits Include:
2-Bus Bar Clamps, 4-GR.8 Bolts, 4-Nuts

Bus Bar Clamp Bolt Length Table				
# Laminations	Clamp Sizes: 4x4 4x6 6x6		Clamp Sizes: 4x8 6x8 8x8	
	0.25" Copper	0.50" Copper	0.25" Copper	0.50" Copper
2	2.75"	3.275"	3.50"	4.00"
3	3.00"	3.750"	3.75"	4.50"
4	3.25"	4.250"	4.00"	5.00"
5	3.50"	4.750"	4.25"	5.50"
6	3.75"	5.250"	4.50"	6.00"
7	4.00"	5.750"	4.75"	6.50"
8	4.25"	6.250"	5.00"	7.00"
9	4.50"	6.750"	5.25"	7.50"
10	4.75"	7.250"	5.50"	8.00"
11	5.00"	7.750"	5.75"	8.50"
12	5.25"	8.250"	6.00"	9.00"
13	5.50"	8.750"	6.25"	9.50"
14	5.75"	9.250"	6.50"	10.00"
15	6.00"	9.750"	6.75"	10.50"
16	6.25"	10.250"	7.00"	11.00"
17	6.50"	10.750"	7.25"	11.50"
18	6.75"	11.250"	7.50"	12.00"
19	7.00"	11.750"	7.75"	12.50"
20	7.25"	12.250"	8.00"	13.00"

Bus Bar Clamps and Kits				
Part Number	Est. Wt.	"A"	"B"	"C"
DA-750426	3.1 lbs	4.00	4.00	1/2-13
DA-750427	3.3 lbs	4.00	6.00	1/2-13
DA-750428	3.6 lbs	6.00	6.00	1/2-13
DA-750429	3.6 lbs	4.00	8.00	5/8-11
DA-750430	7.1 lbs	6.00	8.00	5/8-11
DA-750431	7.8 lbs	8.00	8.00	5/8-11
DA-750426-K	7 lbs	4.00	4.00	1/2-13
DA-750427-K	7.5 lbs	4.00	6.00	1/2-13
DA-750428-K	8 lbs	6.00	6.00	1/2-13
DA-750429-K	8 lbs	4.00	8.00	5/8-11
DA-750430-K	15 lbs	6.00	8.00	5/8-11
DA-750431-K	17 lbs	8.00	8.00	5/8-11

Rec. Torque Specifications:
40 ft. lbs.

Rec. Torque Specifications:
40 ft. lbs.

TYPICAL CHEMICAL ANALYSIS* AISI C-1045					MINIMUM KEEL BLOCK TEST BAR PROPERTIES					TYPICAL HARDNESS
C%	MN%	SI%	P% Max.	S% Max.	Ultimate Strength PSI	Yield Strength PSI	Elong. In 2" %	Red. In Area	Heat Treatment	Brinell Hardness
0.45	0.7	0.45	0.05	0.05	90,000	60,000	20	40	Q&T	180-230

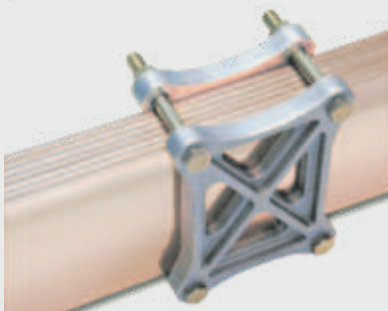

*Medium Carbon Steel - Investment castings produced from these steels are readily machinable, readily welded, and have excellent Ductility.
Finish Required - Hot Dip Galvanized



This page was left blank intentionally



D. A. International Casting Co.

23 Mansfield Industrial Pkwy Mansfield, Ohio 44903

Phone: 419.522.2278 Fax: 419.524.1688

www.dacasting.com

